

**IEA Bioenergy Task 32 report**

*FINAL REPORT*

# **Status overview of torrefaction technologies**

Jaap Koppejan, Procede Biomass, Netherlands  
Shahab Sokhansanj, UBC, Canada  
Staffan Melin, UBC, Canada  
Sebnem Madrali, CanmetENERGY

Enschede, December 2012



This report was produced for IEA Bioenergy Task 32

#### Disclaimer

The statements, technical information and recommendations contained herein are believed to be accurate as of the date hereof. Since the conditions and methods of the use of the products and of the information referred to herein are beyond our control, IEA Bioenergy, Task 32, Procede and the authors expressly disclaim any and all liability s to any results obtained or arising from any use of the products or reliance on such information. The opinions and conclusions expressed are those of the authors.

#### Authors:

Jaap Koppejan, Procede Biomass BV, PO Box 328, 7500 AH Enschede, The Netherlands, tel +31649867956, jaapkoppejan@procede.nl

Shahab Sokhansanj, Ph.D., P.Eng., Environmental Sciences Division, Oak Ridge National Laboratory, Oak Ridge, TN, cell: 865-207-3081 and Department of Chemical & Biological Engineering, University of British Columbia, Vancouver, BC, Tel: +1-604-904-4272, shahabs@chbe.ubc.ca

Staffan Melin, Biomass and Bioenergy Research Group (BBRG), Department of Chemical and Biological Engineering University of British Columbia, Vancouver, British Columbia, drc@dccnet.com

Sebnem Madrali, CanmetENERGY / Bioenergy Group, Natural Resources Canada, Government of Canada, 580 Booth St., Ottawa, Ontario K1A 0E4, tel. 613-996-3182, sebnem.madrالي@NRCan.gc.ca

December 2012



## Executive Summary

The last 5 years has seen significant increase of interest in torrefaction technologies as a pretreatment technology for solid biomass. This interest has mainly been driven by the characteristics of the torrefied and densified biomass including better transportation characteristics and compatible properties to coal such as heating value, grindability, bulk energy density, and hydrophobicity. Among the various applications being considered for the torrefied & densified biomass, the most likely ones include co-firing with coal in pulverised coal fired power plants and cement kilns, coke and steel industry (for charred biomass), small to medium scale dedicated biomass and pellet burners, and gasification in entrained flow gasifiers that normally operate on pulverized coal.

This report aims to summarise the current status of development of torrefaction technologies including technical and economical aspects and the potential market application from the energy sector perspective. It is based on several recent public reports as well as research and market information from sources such as IEA Bioenergy workshops in 2011 and 2012, direct contacts with technology developers, university and institutional researchers.

In the torrefaction process, biomass is heated to a temperature of approx.. 250-350°C in an atmosphere with low oxygen concentrations, so that all moisture is removed as well as a fraction of the volatile matter of the dry biomass. Ideally, the energy contained in the released volatiles is equal to the heating requirements of the process, so that a thermal efficiency exceeding approx. 95% is achieved. Due to the substantial weight loss and a relatively smaller loss of calorific content, the heating value of processed biomass per mass unit increases significantly in the process.

Through the torrefaction process and depending on its severity, fibrous, tenacious and hydrophylic properties of biomass can be altered so that the end product is brittle (therefore easy to grind) and hydrophobic. These behavioural changes can have significant advantages in the supply chain, since logistics can be made simpler, more cost effective and compatible with coal.

At the time of publishing this review at least 40-50 torrefaction initiatives have been identified about equally divided between Europe and North America. These installations intend to demonstrate the technical and economical feasibility of torrefaction as a viable pre-treatment option and of the torrefied product for cofiring in existing pulverised coal fired power plants. Several of these installations in both Europe and North America have a name tag capacity up to several hundred thousand tonnes. This is driven partly by the need for large commercial scale test burning requiring several thousand tonnes of fuel. As of yet, however, only a handful are actually producing and the greatest challenge is therefore related to successful technical and economical demonstration of the individual technologies. It is still early



to identify the winning technologies but it is likely there will be several viable torrefaction technologies capturing the market over time.

The most important technical challenges in the development of torrefaction technologies are related to the process gas handling and contamination, process upscaling, predictability and consistency of product quality, densification of torrefied biomass, heat integration and the flexibility in using different input materials. The goal is to produce hydrophobic material after torrefaction and convert the hydrophobic material to durable pellet or briquette after densification that can be handled and stored outdoor without weather protection like coal. However, to achieve a durable product able to withstand large scale handling still remains to be proven and is perhaps the most significant challenge still remaining to be resolved.

In addition to difficulty to compact torrefied biomass, the dust from torrefied material is potent and can explode in high concentrations. Issues associated with outdoor storage of torrefied material and leaching is yet to be dealt with and the environmental impact of leaching from weather exposed storage must be better understood.

The results from the economic analysis presented in this report point out added value of torrefaction when compared to conventional wood pellets. Provided that outdoor storage becomes feasible, lower break-even delivered fuel price at the gate of a power plant for torrefaction pellets compared to wood pellets is achievable as a result of the reduced logistical cost. The potential of achieving higher cofiring ratios which in turn will result in further reduction in CO<sub>2</sub> emission will also benefit the economical value. The market price of torrefied biomass pellets is, however, not only determined by the cost, but also the balance between demand and supply. There still exists a need to improve the end-user confidence about combustion properties, grindability, storage behaviour, self heating and self ignition of large amount of torrefied product for safe and reliable operation. When combined with the limited availability of torrefied materials, these issues hamper rapid market development and highlight the need to continue efforts on fundamental and applied research and large scale cofiring demonstration initiatives. The security of supply is a major issue as the large number of potential buyers of torrefied biofuels such as power plants is not likely to rely on supply from a single producer or even a small number of producers. There is also reluctance to rely on supply which is based on a single or proprietary torrefaction technology since it may lock in the buyer. Commercial scale supply to power stations is not likely to become a reality until there is sufficient product available with multiple suppliers using multiple technologies and relying on multiple feedstocks. A consolidated and more open collaboration between producers would advance the common cause but is difficult to cultivate this in a fiercely competitive environment since the technology innovators are often also the producers at this early stage.



Since there is no commercial market fully developed for torrefied biofuels the pricing structure and trend is uncertain. There is obviously a premium to be paid for the higher heat value compared to regular wood pellets and also for the potentially superior handling characteristics based on the assumption that the product can be stored similar to coal. This bonus could be quite high if the experience from the initial large scale bulk handling projects turn out to be successful. It is, however, not possible at this early stage to predict the market price for torrefied pellets. The economics of torrefaction on the producer side require a low cost feedstock due to the significant loss of material during the torrefaction process.

At present, torrefaction processes are largely based on clean biomass resources such as clean waste wood. Due to lower prices and better availability, the interest in waste streams and residues as feedstock for torrefaction is increasing. In order to facilitate the use of such resources, a number of issues related to availability, price, and technical specifications need to be resolved. This particularly relates to the input density, limited throughput capacity, regulatory framework and permitting procedures for co-firing the waste derived materials, special scrutiny due to concerns about emissions and ash quality, boiler integrity (fouling and corrosion) and efficiency. Significant research is under way to explore the potential for using lower cost feedstock from agriculture. This is challenging due to the somewhat unfavourable chemical composition of such feedstock unless significant pre-treatment of the feedstock is done. On the other hand the agri-material feedstock is plentiful and could become a major factor in the long term.

With regard to waste derived torrefaction fuels, regulators may discuss with energy producers how these could be used in existing facilities and to what extent these facilities would have to be operated under the EU Waste Incineration Directive. It could be argued that if a torrefied material has similar performance as the base fuel in a power plant, there is no need to change the emission control devices. It is yet unclear if this complete compatibility can indeed be achieved.

Product quality standards and specific test methodologies for torrefied materials are currently under development by ISO Technical Committee 238, expected to be published during spring 2013 as part of the ISO 17225 Standard, and criteria for sustainability is under development by ISO / PC 248. This standard classifies the torrefied material according to moisture content, ash content, bulk density, fixed carbon content and a minimum net calorific value as received at constant pressure. Torrefied material is currently does not have a safety classification under International Maritime Organization (IMO) and cannot be transported by ocean vessels without special permission since the product has similarities with charcoal, which is prohibited to be transported in bulk. Work is under way to resolve this issue and a classification is expected to be available within the next 12 months.



## Table of contents

<b>EXECUTIVE SUMMARY .....</b>	<b>III</b>
<b>1 INTRODUCTION .....</b>	<b>1</b>
<b>2 BASIC PRINCIPLES OF TORREFACTION .....</b>	<b>2</b>
2.1 PROCESS DIAGRAM .....	2
2.2 THERMAL ENERGY BALANCE .....	4
2.3 BIOMASS CHARACTERISTICS SUITABLE FOR TORREFACTION .....	6
<b>3 ADVANTAGES OF TORREFACTION.....</b>	<b>9</b>
3.1 ALTERNATIVE FEEDSTOCKS .....	9
3.2 PELLETISATION .....	10
3.3 TRANSPORT .....	10
3.4 HANDLING AND STORAGE CHARACTERISTICS .....	11
3.5 GRINDABILITY .....	13
3.6 COMBUSTION CHARACTERISTICS.....	13
<b>4 OVERVIEW OF TORREFACTION TECHNOLOGIES.....</b>	<b>15</b>
4.1 ROTATING DRUM .....	15
4.2 SCREW TYPE REACTORS.....	16
4.3 MULTIPLE HEARTH FURNACE (MHF) OR HERRESHOFF OVEN .....	17
4.4 TORBED REACTOR.....	18
4.5 MOVING COMPACT BED .....	19
4.6 BELT DRYER .....	21
4.7 MICROWAVE REACTOR .....	21
<b>5 APPLICATIONS OF TORREFIED BIOMASS .....</b>	<b>22</b>
5.1 CO-FIRING IN PULVERISED COAL FIRED POWER PLANTS .....	22
5.2 GASIFICATION.....	23
5.3 BLAST FURNACES.....	23
5.4 STANDALONE COMBUSTION .....	23
<b>6 ECONOMIC VALUE OF TORREFACTION PELLETS.....</b>	<b>25</b>
6.1 ASSUMPTIONS .....	25
6.2 RESULTS.....	28
<b>7 OVERVIEW OF PROJECT INITIATIVES .....</b>	<b>30</b>
7.1 TOPELL B.V. (TOPELL) .....	32
7.2 GREEN INVESTMENTS (SGI) .....	32
7.3 TORR-COAL B.V.....	33
7.4 BIOLAKE B.V.....	33
7.5 AIREX ENERGY .....	34
7.6 ANDRITZ/ACB TORREFACTION TECHNOLOGY .....	35



7.7	ANDRITZ/ECN TORREFACTION TECHNOLOGY .....	36
7.8	NEW BIOMASS ENERGY .....	37
7.9	EARTH CARE PRODUCTS INC. ....	39
<b>8</b>	<b>THE NETHERLANDS AS CASE STUDY .....</b>	<b>40</b>
8.1	DEMAND FOR BIOMASS FOR ENERGY .....	40
8.2	DEVELOPMENT OF THE DUTCH MARKET FOR TORREFIED BIOMASS .....	40
8.3	TORREFACTION OF DOMESTIC BIOMASS STREAMS .....	41
<b>9</b>	<b>CHALLENGES FOR MARKET IMPLEMENTATION .....</b>	<b>44</b>
9.1	TECHNICAL CHALLENGES .....	44
9.2	MACROECONOMIC CHALLENGES .....	46
9.3	REGULATORY ISSUES .....	47
<b>10</b>	<b>RECOMMENDATIONS.....</b>	<b>49</b>
<b>11</b>	<b>CONCLUSIONS .....</b>	<b>51</b>
<b>12</b>	<b>REFERENCES .....</b>	<b>53</b>



## 1 Introduction

Over the last decade, torrefaction technology has been rapidly developed from pure R&D to the stage of market introduction and commercial operation. The first contracts for off-take to energy companies were recently signed and indications are that torrefaction has a potential to replace over time the wood pellets as a standard solid biomass fuel for co-firing in a pulverised coal fired power plant. The torrefied pellets have superior characteristics in terms of compatibility with coal (ie. heating value, grindability, bulk energy density, hydrophobic aspects, etc) which potentially avoid costly power plant modifications. Particularly in the current investment climate with uncertainties in political support for biomass co-firing and CO<sub>2</sub> price development, increasing operating expenses (OPEX) while avoiding capital expenses (CAPEX) is often preferred.

This report presents an overview of the current status of torrefaction technologies and their market perspectives. It is largely based on a technology status overview prepared by KEMA (involved in Task 32) for the Dutch government in 2010. Additional information collected in 2011 and 2012 was incorporated to update the document.

The report starts with an analysis of the basic principles of torrefaction, and the way different torrefaction technologies have been designed. The market for torrefied biomass is then briefly assessed.

The current market demand for torrefied fuels is due to two factors. The requirement for closing of older power plants reaching the end of their regulated life cycle in combination with the potentially superior characteristics compared to non-torrefied biomass currently used for co-firing. A business case is presented where the conventional wood pellet chain is compared with that for torrefied pellets.

This report also contains an assessment of the domestic market in the Netherlands, by combining information on locally available biomass resources and end users criteria. The reader may use the model in the report to evaluate the effect of market conditions in other countries.

Further, this report provides an overview and assessment of the current torrefaction initiatives under development in Europe and North America. Finally, the most important technical challenges, and market and policy related barriers are discussed.

The main objective of the report is to provide additional insight on the current technology status and market perspectives on torrefaction technologies, the results of this report should therefore not be used for the qualification of a specific technology or product market price. Finally, the reader should note that IEA Bioenergy Agreement has published another report under Task 40 on the potential impact of torrefaction on international trade in solid biofuels.



## 2 Basic Principles of torrefaction

Lignocellulosic biomass typically contains approx. 80 % volatile matter and 20 % fixed carbon on dry mass basis. During the torrefaction process, solid biomass is heated in the absence of or drastically reduced oxygen to a temperature of approx. 250-350°C, leading to a loss of moisture and partial loss of the volatile matter in the biomass. With the partial removal of the volatile matter (about 20%), the characteristics of the original biomass are drastically changed. Torrefaction is different from steam explosion, and results in different product characteristics.

During the torrefaction process, the tenacious fibre structure of the original biomass material is largely destroyed through the breakdown of hemicellulose and to a lesser degree of cellulose molecules, so that the material becomes brittle and easy to grind [Ciolkosz et al, 2011]. The material then changes from being hydrophilic to becoming hydrophobic. With the removal of the light volatile fraction that contains most of the oxygen in the biomass, the heating value of the remaining material gradually increases from 19 MJ/kg to 21 or 23 MJ/kg for torrefied wood and eventually 30 MJ/kg in the case of complete devolatilization resulting in charcoal.

### 2.1 Process diagram

Although there are some variations in the range of process conditions applied for the various reactor concepts, the basic concept for torrefaction and densification processes is the same and commonly incorporates heat integration, see Figure 2.1.

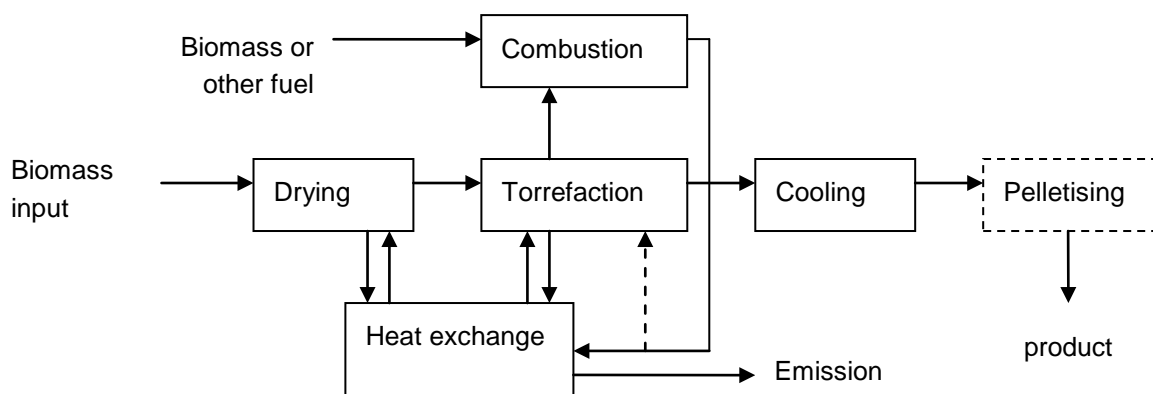

Figure 2.1 Overview of heat integration options.

The thermal energy required for the drying and torrefaction process can be implemented in the following ways:

- Recirculation of flue gas for direct or indirect process heating: the direct heat exchange between biomass particles and the flue gas is rather efficient and



- eliminates the need for heat exchangers. The main concern is related to the extent of the biomass loss due to oxygen in the flue gas. Further, the investment in flue gas pipes is relatively high due to the large volume flows.
- Recirculation of torrefaction gas for process heating: part of torrefaction gas is preheated in a heat exchanger with heat extracted from the flue gas, resulting from burning of the torrefaction gas. Despite some heat loss in the heat exchanger, this is an efficient method, similar to recirculation of flue gas, and does not lead to increased oxygen levels inside the reactor. It is important to maintain high enough temperatures of the recirculated torrefaction gas in order to minimize the condensation of tar in the heat exchange surfaces. Further, direct injection of volatiles back into the reactor might result in tar formation from polymerization reactions between organic hydrocarbons (phenols, furfural) and acids (formic acid, acetic acid). Recirculating torrefaction gas increases the concentration levels of these components, resulting in more tars. One should therefore take measures to specifically remove tars from the recirculated process stream.
  - Recirculation of (supercritical) steam for direct or indirect process heat: steam is produced in a boiler fired with torrefaction gas. In case of direct heating, heat contained in the steam is more efficiently transferred to the biomass as compared to indirect heating, however, the presence of steam in the gas flow leaving the reactor might cause additional challenges in terms of process design complexity and installation materials used. In case of indirect heating using steam or flue gas (e.g. from the reactor wall), there is an increased risk of hot spots inside the torrefaction reactor, causing an increased risk for char formation.

In a properly designed and operated torrefaction system, the energy contained in the torrefaction gases may be sufficient to sustain both the drying process and the torrefaction process. However, this strongly depends on the moisture content of the incoming biomass (latent heat requirement) and the required degree of torrefaction (the degree of mass loss and the availability of combustible volatiles). It is therefore important to dry the biomass before it enters the torrefaction reactor, since moisture entering the torrefaction reactor results in more wet torrefaction gas which lowers the adiabatic flame temperature. For very wet torrefaction gas, there might not even be sufficient energy contained in the gas to reach a temperature for complete combustion (at least 900 °C required). For this reason, moisture content of incoming biomass to the torrefaction reactor should not exceed approx. 15%. However, depending on the torrefaction concept and the economics of the feedstock considerably higher moisture content may turn out to be beneficial. The net efficiency of an integrated torrefaction process is approx. 70 - 98%, depending on the reactor technology, concept for heat integration and the biomass type.

One way to increase the overall efficiency is by adding residual heat from another process (such as a gas engine or waste incinerator) to dry the biomass. In the past KEMA has examined options to integrate the existing water/steam circuit of a coal fired power plant with a torrefaction plant, however this option appears to be relatively



expensive and negatively influences the complexity, controllability and availability of both the energy production and torrefaction processes.

## 2.2 Thermal energy balance

Figure 2.2 illustrates the thermal process efficiency, defined as the LHV of the torrefied product divided by the total LHV of the input biomass against the moisture content of input biomass. It is assumed here that the volatile gases released during torrefaction are combusted to dry the input biomass, and supplemented with combustion of additional biomass fuel. The thermal process efficiency depends on the removal of volatiles and the moisture content of the input biomass used.

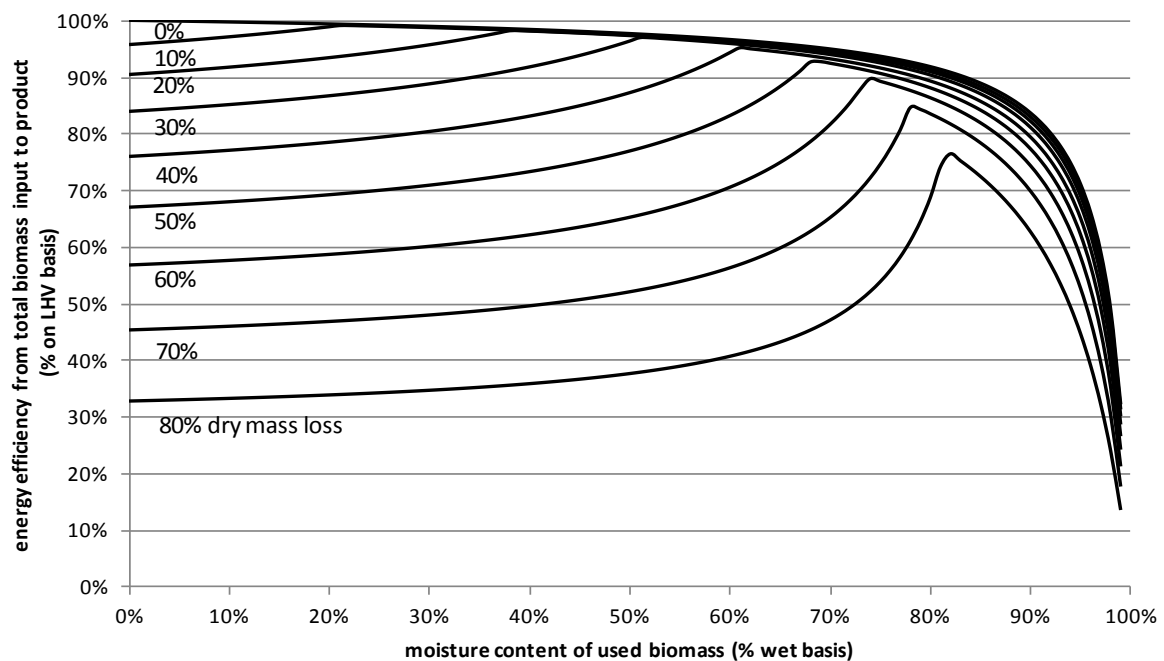

Figure 2.2 Theoretical thermal efficiency of an integrated torrefaction process, assuming clean wood (0,5% ash content) as raw material and heat requirement of the drier of 2.9 MJ per kg of water evaporated (75% efficiency).

The Figure 2.2 shows that for typical torrefaction conditions where about 20% of the dry mass is removed in the form of volatile gases (often named 'torgas'), the thermal energy efficiency of the torrefaction process shows very high conversion efficiencies exceeding 90%, since the energy contained in the removed volatile fraction can be used to drive off the moisture in the dryer.

The process efficiency drops with higher devolatilisation rates (more than about 20-30%) and lower moisture content biomass, because the energy contained in the released volatiles is more than what is required for removing moisture in the biomass



dryer. The process efficiency is also less than optimal for wet biomass fuels (e.g. green wood, fresh grasses, etc.) due to the inefficiency of the dryer.

At the point where there is just enough energy in the torgas to energize the process, no additional biomass is required to evaporate moisture. Autothermal operation and the maximum thermal efficiency can be achieved for a desired devolatilisation rate. In practise, autothermal state is a theoretical condition and achieving that for a real process would be difficult due to complexity of simultaneous multi reactions. For this reason, torrefaction processes in practise will exhibit slightly less than optimal performance.

First experiences with torrefaction indicate that for replacing hard coal at modest co-firing ratios, a torrefaction degree of approx. 20% dry mass loss is appropriate. The above graph shows that this can be achieved with relatively high conversion efficiencies for relatively wet biomass. The theoretical energy balance for this situation, assuming 1 kg of fresh wood with a moisture content of 50% as input is shown in Figure 2.3. The figure illustrates that 98% of the original heating value can be transferred to only 37% of the original mass.

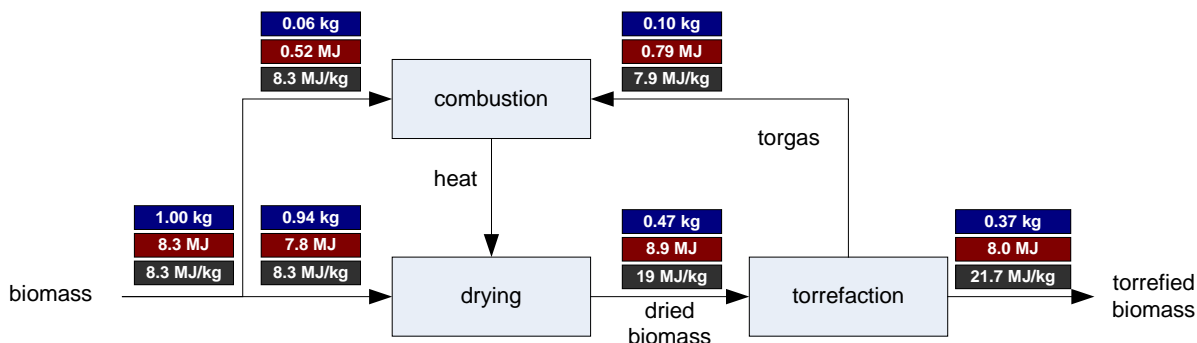

Figure 2.3 Mass and energy flows for an integrated torrefaction process, assuming fresh clean wood (0,5% ash content, 50% moisture content ) as raw material and a dryer requiring 2.9 MJ per kg of water evaporated (source: Topell Energy). This diagram shows the thermal energy balance based on the same assumptions as Figure 2.2, in addition electrical energy is required for densification, fans, drives, etc.

For very high devolatilisation rates, however, (going from torrefaction to carbonisation), the large amounts of energy released with the volatiles is more than what is needed for drying the input material, therefore the process efficiency significantly drops unless the excess heat is recaptured for torrefaction operation.

In addition to the thermal efficiency, electric energy is consumed for several process steps (conveyors, dryers, pellet presses etc.). Given the same amount of input material, a torrefied pellet plant do not have a higher electricity consumption than a



conventional wood pellet plant since the electricity consumption of the torrefaction reactor is more or less compensated by the lower electricity consumption for grinding material before pelletisation. It is not clear yet if less power is needed for pelletisation.

### **2.3 Biomass characteristics suitable for torrefaction**

Not all biomass resources are optimal as a feedstock for torrefaction. In addition to suitability of biomass for torrefaction, the torrefaction process needs to lead to substantial improvements in physical properties of the biomass to enable new applications.

#### **Physical and chemical characteristics of biomass:**

Clean and dry lignocellulosic biomass sources, containing substantial fractions of cellulose, hemicellulose and lignin are suitable for torrefaction, as these materials become more compatible with existing pulverized coal fired power plants. However, biomass types such as meat and bone meal which has already good grindability characteristics and high calorific values, can be cofired to substantial co-firing ratios without torrefaction and are therefore less interesting for torrefaction.

The chemical composition of the biomass material is also a factor to consider. Because of the relatively low temperature of the torrefaction process, most critical chemical fuel components (alkali metals, chloride, sulphur, nitrogen, heavy metals and ash) remain in the fuel after torrefaction. This makes clean biomass feedstocks the preferred option for the foreseeable future.

Besides the chemical composition, the physical characteristics of biomass plays an important role when assessing the potential for torrefaction. Due to the limited options for internal transportation and filling inside the reactor, biomass with a low bulk density ( $< 100 \text{ kg/m}^3$ ), such as straw and grass, negatively influences the technical and economic feasibility. In addition, small and light biomass particles risk being entrained with the flow of volatiles released and removed from the reactor instead of converted to the wanted solid product. Blockage of feeding screws and pneumatic conveyors from the tenacious biomass might impose another problem.

In general it can be stated that processing bulky biomass resources with the currently available torrefaction technologies is limited for various technical and economical reasons. These reasons are, however, not fundamental, and it can be expected that if such resources are available at low prices, torrefaction technologies can be properly adapted to enable techno-economically sound operation on these resources. Pelletising such biomass resources beforehand eases the feeding problems for torrefaction. But depending on the degree of torrefaction, torrefied regular pellets have a lower density and durability than the untreated regular pellets.



**Torrefaction technology technical specifications for biomass:**

Wet biomass such as animal litter and sludges are not directly suitable for torrefaction and need to be dehydrated first from approx. 75% down to 15-40% moisture content. This may require an extra step of solids drying and add extra cost. It should be noted that ECN (The Netherlands) is currently conducting research on a new technology called TorWash, in which wet and contaminated biomass is torrefied in a single pressurized process in water. As a result, water soluble contaminants (salts) are largely washed out in the process, so that the product contains less of these components. After torrefaction, water is mechanically removed from torrefied biomass down to approx. 40% moisture content. Although this torrefaction process is potentially interesting for the use with wet biomass types, the process is still in its infancy and not yet technically and financially feasible. An important issue is the remaining moisture content in the torrefied biomass after the process must be removed. Dealing with effluents from this process is another hurdle to overcome. Another wet torrefaction technology referred as hydrothermal carbonisation (HTC) is being developed by Desert Research Institute with support from Gas Technology Institute.

The use of biomass as an energy carrier is often too expensive when competing with production of other high value commodities such as paper and fibreboard. In remote areas where large amounts of lignocellulosic biomass are grown and long term, reliable biomass supply can be arranged to a local facility at low cost, the high cost of transportation to the distant end users can be reduced somewhat through torrefaction and pelletisation assuming that there exists adequate infrastructure for harvesting, transporting and processing including trained man power.

**Product compliance with environmental requirements:**

Contaminated biomass such as painted wood may release heavy metals during the torrefaction process, which may necessitate the need for extensive flue gas treatment. Together with the more complex permitting procedure, it generally makes such feedstock less attractive than clean biomass.

The ISO Technical Committee 238 has developed a comprehensive classification and specification matrix (ISO 17225-1 Standard) for a large number of solid biomass materials, including woody, herbaceous, fruity and aquatic biomass.

In addition, ISO/TC 238 is currently developing product quality standards and specific test methodologies for torrefied materials, the publication is expected in the spring of 2013. This Standard classifies the torrefied material according to moisture content, ash content, bulk density, fixed carbon content and a minimum net calorific value as received at constant pressure. Table 2.1 below is an excerpt from ISO 17225-1 Standard.



Torrefied material currently does not have an approved safety classification under International Maritime Organization (IMO) for ocean transportation in bulk and can not be transported by ocean vessels without special permission since the product has similarities with charcoal, which is prohibited to be transported in bulk. Work is under way to resolve this issue and a classification is expected to be available within the next 12 months.

Table 2.1 Specification of properties for thermally treated biomass (e.g. mild form pyrolysis/torrefaction) . Replicated with permission from the ISO 17225-1 Standard

<b>Master table</b>	
<b>Origin:</b> According to 6.1 and Table 1	Woody biomass (1); Herbaceous biomass (2); Fruit biomass (3); Aquatic biomass (4); Blends and mixtures (5).
<b>Traded Form</b> (see Table 2)	Thermally treated biomass
<b>Dimensions</b> (mm)	to be stated
<b>Moisture, M</b> (w-% as received) ISO XXXXX	
<b>M3</b>	≤ 3 %
<b>M5</b>	≤ 5 %
<b>Ash, A</b> (w-% of dry basis) <b>ISO 18122</b>	
<b>A0.5</b>	≤ 0,5 %
<b>A0.7</b>	≤ 0,7 %
<b>A1.0</b>	≤ 1,0 %
<b>A1.5</b>	≤ 1,5 %
<b>A2.0</b>	≤ 2,0 %
<b>A3.0</b>	≤ 3,0 %
<b>A5.0</b>	≤ 5,0 %
<b>A7.0</b>	≤ 7,0 %
<b>A10.0</b>	≤ 10,0 %
<b>A10.0+</b>	> 10,0 % (maximum value to be stated)
<b>Bulk density (BD) as received (kg/m<sup>3</sup>) ISO 17828</b>	
<b>BD200</b>	≥ 200
<b>BD250</b>	≥ 250
<b>BD300</b>	≥ 300
<b>Net calorific value as received, Q</b> (MJ/kg) <b>ISO 18125</b>	≥ 19 MJ/kg (minimum value to be stated)
<b>Fixed carbon, C</b> , ISO XXXXX	
<b>C20</b>	≥ 20
<b>C25</b>	≥ 25
<b>C30</b>	≥ 30
<b>C35</b>	≥ 35
<b>C40</b>	≥ 40
<b>Volatiles, VM</b> , w-% dry, <b>ISO 18123</b>	Maximum value to be stated



### 3 Advantages of torrefaction

Torrefaction results in a high quality fuel, with characteristics compatible with coal as Table 3.1 illustrates. The increase in calorific value is caused by the removal of moisture and some organic compounds from the original biomass. A fundamental difference with charcoal is the difference in volatile matter; in torrefaction processes the aim is to maintain volatile matter (and thereby energy) as much as possible in the fuel.

Table 3.1 Variety in fuels suitable for biomass co-firing [KEMA, 2010]

	Wood	Wood pellets	Torrefaction pellets	Charcoal	Coal
Moisture content (% wt)	30 – 45	7 – 10	1 – 5	1 – 5	10 – 15
Lower heating value (MJ/kg)	9 – 12	15 - 18	20 – 24	30 – 32	23 – 28
Volatile matter (% db)	70 – 75	70 – 75	55 – 65	10 – 12	15 – 30
Fixed carbon (% db)	20 – 25	20 – 25	28 – 35	85 – 87	50 – 55
Density (kg/l) Bulk	0.2 – 0.25	0.55 – 0.75	0.75 – 0.85	~ 0.20	0.8 – 0.85
Energy density (GJ/m <sup>3</sup> ) (bulk)	2.0 – 3.0	7.5 – 10.4	15.0 – 18.7	6 – 6.4	18.4 – 23.8
Dust	Average	Limited	Limited	High	Limited
Hydroscopic properties	hydrophyllic	hydrophilic	hydrophobic	hydrophobic	hydrophobic
Biological degradation	Yes	Yes	No	No	No
Grindability	Poor	Poor	Good	Good	Good
Handling	Special	Special	Good	Good	Good
Quality variability	High	Limited	Limited	Limited	Limited

During the torrefaction process, the relative concentrations of chloride and sulphur are more or less maintained since these fuel components are not released at the typical torrefaction temperatures. The ash content increases slightly since part of the dry matter in the original biomass is lost during the process.

From the data in Table 3.1 it can be concluded that torrefaction yields a number of important advantages, which will be discussed in more detail below.

#### 3.1 Alternative Feedstocks

Most types of biomass contain hemicellulosic and cellulosic polymers. For this reason, torrefaction can be performed on virtually any lignocellulosic type of biomass, and it is possible in theory to design a torrefaction plant for a wider diversity of feedstock, to produce a more homogeneous product. Research projects such as the “Production of Solid Sustainable Energy Carriers by Means of Torrefaction (SECTOR) “ and “Agricultural Biomass Torrefaction Research Program” led by CEATI International Inc., that are currently under way, aim to torrefy different alternative lignocellulosic feedstocks, such as road side grass, straw, hay and other agro-residues and evaluate the feasibility of efficient use of alternative feedstock for torrefaction. Since the experience with torrefaction of well defined input materials to a





properly defined output material is still limited, it will take some time before commercially operated torrefaction plants with alternative and multiple input materials are in operation. The next chapters elaborate some of the options for increased fuel flexibility.

### **3.2 Pelletisation**

By pelletising torrefied biomass, a number of advantages can be achieved in transport, handling and storage. While the volumetric energy density (in GJ per m<sup>3</sup>) of torrefied biomass chips is more or less equal to that of the original material (wood chips), the compression step increases this by a factor of 4-8 leading to significant cost savings in shipping and storage, shipping meaning transportation with truck, train or ocean vessel.

The pelletised product causes less dust emissions, can be pneumatically transported to intermediate storages or the coal pulverizers or hammer mills and is less sensitive to degradation and moisture uptake when compared to chips or pulverised fuels. The energy consumption of the pelletisation process itself is higher per ton of torrefied biomass if compared to e.g. wood pellets (about 150 kWh/ton vs 50-60 kWh/ton), however, research is ongoing to reduce this. The high friction in the press channels of the pellet mill leads to heat generation and consequently risk of fire/dust explosion [Stelte et al, 2012].

The mechanical strength of the resulting torrefied pellets can be in some cases be similar to conventional wood pellets. Lignin plays an important role in the internal binding of the pellet and so does the moisture content. During the torrefaction process lignin partly degrades, depending on the process conditions. Therefore, preparing a strong pellet requires optimization of the process conditions during torrefaction as well as pelletization such as increased pelletization temperature or exerting high pressures. A number of companies involved in torrefaction consider using binders such as glycerine, paraffine, molasse, lignin, bioplastics or condensable fraction of torrefaction gas. Injection of water mist in the torrefied material prior to the pelletization appears to also improve the binding characteristics. This area is subject to intensive research at this time.

### **3.3 Transport**

During torrefaction, the bulk density decreases due to the decrease in mass (moisture and volatiles) while almost maintaining the original volume. In non-densified form the torrefied material is relatively difficult and expensive to handle and transport, due to the low energy density (3 to 3,3 GJ/m<sup>3</sup>) and the high risk for dust emissions. Pelletising torrefied biomass mitigates these problems and makes the product significantly better for long distance transportation. Although there is a lack of reliable density data for torrefied pellets, it can be assumed that the energy density of torrefied pellets increases to about 15 - 18 GJ/m<sup>3</sup>, which is significantly higher than



regular wood pellets (8 - 10 GJ/m<sup>3</sup>). In addition, freshly pressed torrefied biomass pellets are less sensitive to degradation than wood pellets and the risk for self heating / self ignition decreases, though freeze and thaw cycles may still significantly deteriorate the product.

Based on the current economics of regular wood pellets trade, the added costs of pelletisation are compensated by the reduction in transportation costs (e.g. from Eastern Europe or North America to Western Europe). In case biomass is available near the power plant where it is used, this may not be the case, provided the power plant can process non-pelletized material. Transportation distances are therefore an important factor for the design of the torrefaction installation and the business case.

Torrefied material, pelletized or non-pelletized is not permitted to be transported in ocean vessels until a safety code has been approved by the International Maritime Organization (IMO). The approval process has been initiated with the earliest expected approval date mid 2013. Other regulations for transportation by rail or road may also apply in local jurisdictions.

### **3.4 Handling and Storage Characteristics**

As a result of pelletised torrefied material, the volume to handle and store is significantly reduced. Also due to the higher energy density of torrefied pellets, less mass is required for the same energy production as compared to wood pellets. This results in significant savings in handling and storage at the power plant, particularly if weather protected storage is not required.

Another important factor in this regard is the hydrophobic character of torrefied material. During the torrefaction process, OH-groups are substituted by unsaturated non-polar groups, which results in a great loss of water adsorbing capacity. The hydrophobic characteristics of torrefied material make the fuel less sensitive for degradation (rotting), self heating and moisture uptake. After torrefaction, the adsorption of moisture and water will decrease as a function of degree of torrefaction. Figure 3.1 illustrates the hygroscopic characteristics of one type of torrefied pellets as a function of time and relative humidity at a certain ambient temperature. The use of binder or additive and other types of feedstock may show slightly different results.

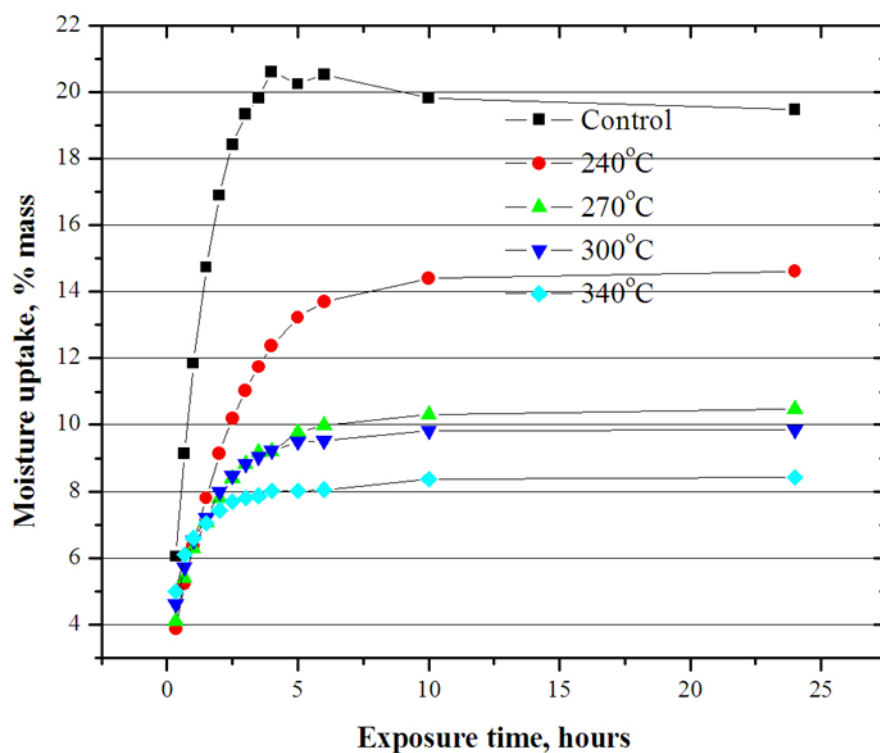

Figure 3.1 Hygroscopicity of 6 mm pellets made from torrefied wood at temperatures from 240-340 °C. The control is regular white pellets, Tests were done at 30°C and 90% relative humidity (RH). UBC/CHBE, feb, 2011.

In addition to the hygroscopic adsorption there is also absorption of water if exposed to moisture in liquid form (e.g. rain). The water absorption has showed a tendency of generating leaching of unknown composition.

ISO Technical Committee 238 is developing testing standards for determination of hygroscopicity (sorption of relative humidity in air), absorbancy of water and freezing characteristics. The hydrophobicity is not the focus of determining the weather-resistance of torrefied pellets but rather the effect on durability caused by hygroscopic sorption, water absorbancy and destruction of the mechanical integrity of the pellets. Therefore each one of these test are completed with a standard durability test. The key concern for the large power plants is not the hydrophobic characteristics as such but rather the risk of dust generation during storage and handling since the dust is highly explosive.

While wood pellets need to be stored in a completely enclosed silos, a covered storage may suffice for torrefied pellets although this is an area requiring more research; and will be conducted under the SECTOR Project. The risk of self heating is not yet well addressed due to the insufficient quantities at which torrefied biomass is currently available for practical testing. Results from small scale research show that torrefied pellets show a slower rate of off-gassing during storage and a different

ratio between carbon-monoxide and carbon-dioxide compared to regular wood pellets. But eventually the net amount of off-gas release is equivalent to the same amount of gas released from regular pellets.

### 3.5 Grindability

The torrefied product is brittle due to the breakdown of hemicelluloses and, to a lesser degree, lignin and cellulose. These biomass components normally comprise the fibre structure, which limits the grindability in the conventional coal pulverizer. When biomass is torrefied at 260 - 300 °C for 20 minutes, the tenacious fibre structure will be largely destroyed. Compared to the original woody biomass, milling torrefied wood in a hammer mill requires about 50-85% less energy consumption and increase the throughput by about 2 to 6.5% [Bergman, 2005]. It should be noted that no results of full scale grinding with pulverizer or hammer mill of torrefied material have been published yet. The grindability also depends on the torrefaction technology, mill type, milling conditions, biomass characteristics and feed-in arrangement .

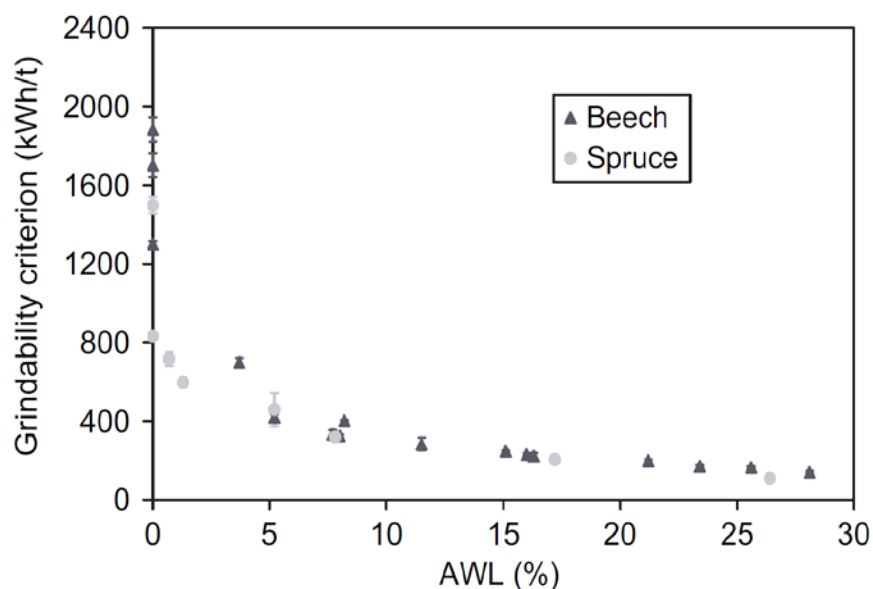

Figure 3.2 Grinding energy required to reduce the particle size below 200  $\mu\text{m}$ , per ton of material that has the top size of 200  $\mu\text{m}$ . AWL stands for Anhydrous Weight Loss (Dry Matter Loss) [Repellin et al. , 2010].

### 3.6 Combustion characteristics

Many different factors determine the combustion quality that can be achieved when burning a certain fuel in a certain installation, such as heating value, moisture content, ash content, reactivity and particle size. The calorific value of torrefied wood can reach a calorific value close to coal and is very dry (moisture content lower than 5%). It contains less ash than coal (0.7 to 5% db, compared to 10 to 20% db for coal)



and has a higher reactivity, largely due to the high amounts of volatile matter (55 - 65% db compared to 10 - 12% db for coal). Spence® simulations indicated that the effect on the performance of the boiler when co-firing high percentages of torrefied material (> 56% mass basis) is minimal [KEMA, 2010]. Due to co-firing of torrefied material, the temperature profile inside the boiler slightly shifts, resulting in an increased boiler exit temperature. The efficiency of the boiler does not need to deteriorate since this can be corrected using moderate process control adaptations.

One issue regarding the combustion characteristics is increased reactivity of the fuel, which is largely caused by the significantly increased internal surface area of the fuel particles due to the evaporation of volatile matter. This may lead to shorter, more intense flames in pulverised coal burners.

Although a number of research projects have recently been initiated on the reactivity and combustion properties of torrefied material, no experimental data has yet been published.



## 4 Overview of Torrefaction Technologies

Different reactor technologies which were developed for other applications are currently being modified to perform torrefaction. Some torrefaction technologies are capable of processing feedstock with small particles such as sawdust and other are capable of processing large particles. Only a few can handle a large spectrum of particle sizes. This means that selection of technology needs to be done based on the characteristics of the feedstock, or alternatively, the feedstock needs to be pre-processed before torrefaction using size reduction equipment, scalpers for handling over-sized material or sieves for extraction of particles of smaller particles. These considerations all have an effect on the capital cost as well as the operating cost of a torrefaction plant.

Table 4.1 provides an overview of the most important reactor technologies and the companies involved.

Table 4.1 Overview of reactor technologies and some of the associated companies

Reactor technologies	Companies involved
Rotating drum	CDS (UK), Torr-Coal (NL), BIO3D (FR), EBES AG (AT), 4Energy Invest (BE), BioEndev/ ETPC (SWE), Atmosclear S.A. (CH), Andritz , EarthCare Products (USA)
Screw reactor	BTG (NL), Biolake (NL), FoxCoal (NL), Agri-tech Producers (US)
Herreshoff oven/ Multiple Hearth Furnace (MHF)	CMI-NESA (BE), Wyssmont (USA)
Torbed reactor	Topell (NL)
Microwave reactor	Rotawave (UK)
Compact moving bed	Andritz/ECN (NL), Thermya (FR), Buhler (D)
Belt dryer	Stramproy (NL), Agri-tech producers (USA)
Fixed bed	NewEarth Eco Technology (USA)

The most important reactor technologies are briefly described below, after which they will be compared based on a number of technical criteria.

### 4.1 Rotating drum

The rotating drum is a continuous reactor and can be regarded as proven technology for various applications. For torrefaction applications, the biomass in the reactor can be either directly or indirectly heated using superheated steam or flue gas resulting from the combustion of volatiles. The torrefaction process can be controlled by varying the torrefaction temperature, rotational velocity, length and angle of the drum.



The drum rotation causes particles in the bed to mix properly and exchange heat, however the friction on the wall also increases the fine fraction. Rotating drums have a limited scalability, therefore higher capacities would require modular setup.

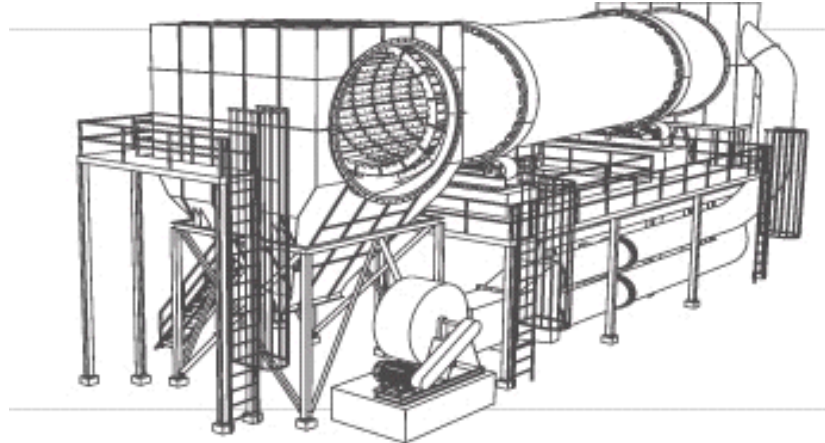

Figure 4.1 Rotating drum reactor

## 4.2 Screw type reactors

A screw type reactor is a continuous reactor, consisting of one or multiple auger screws that transport the biomass through the reactor. The reactor technology can be considered as proven technology, and can be placed both vertically as well as horizontally. A screw reactor is often heated indirectly using a medium inside the hollow wall or hollow screw, however, there are variations of the reactor concept where heat is applied directly using a twin screw system. A disadvantage of indirectly heated screw reactors is the formation of char on the hot zones. Further, the addition of heat in a screw reactor is rate limited because of the limited mixing of the biomass. The residence time inside the reactor is determined by the length and rotational velocity of the screw. A screw reactor is relatively inexpensive, however, the scalability is limited because the ratio of screw surface area to reactor volume decreases for larger reactors. However, there are reactors designed with highly efficient agitation for improved heat transfer which makes large screw reactors highly efficient.

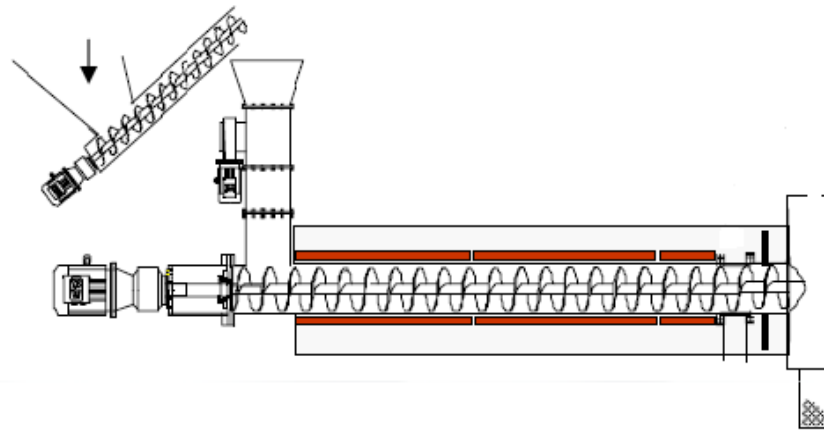

Figure 4.2 Auger screw type reactor

### 4.3 Multiple Hearth Furnace (MHF) or Herreshoff oven

This is a continuous reactor, consisting of multiple layers. It has been proven for various other applications. On every individual layer, a single phase in the torrefaction process takes place. Over the layers, the temperature gradually increases from 220 °C to 300 °C. Biomass enters from the top side of the reactor on a horizontal plate, and is pushed mechanically to the inside. It then falls down through a hole in the plate on a second plate, where biomass is pushed mechanically to the outside, where it falls through another hole, etc. The process is repeated over multiple layers, causing uniform mixing and gradual heating. Heat is applied per individual reactor layer directly using internal gas burners and steam injection. In the upper reactor layers, biomass first dries, in the lower layers torrefaction takes place. The MHF reactor can be scaled up to a diameter of 7 to 8 meter, which results in relatively low specific investments (expressed in EUR per ton/h of product) for large scales. The burners may use natural gas or suspension burners for wood dust from the feedstock. The use of natural gas however for generation of the sweep gas through the reactor contributes to the moisture level and therefore to the moisture content of the torrefied material. This may not necessarily be negative since moisture improves the durability of the pellets after extrusion. Some producers inject moisture in the torrefied material before pelletization. However, natural gas is a fossil fuel and has an affect on the GHG balance for the final torrefied biofuel.

This technology can process wider particle size material from saw dust to large chips and even oversize sticks. The technology lends itself also to research since each step of the torrefaction sequence can be conveniently accessed for material and gas sampling, accurate adaptive temperature control and even injection of additives. Typical processing time is 30 minutes from top to bottom.



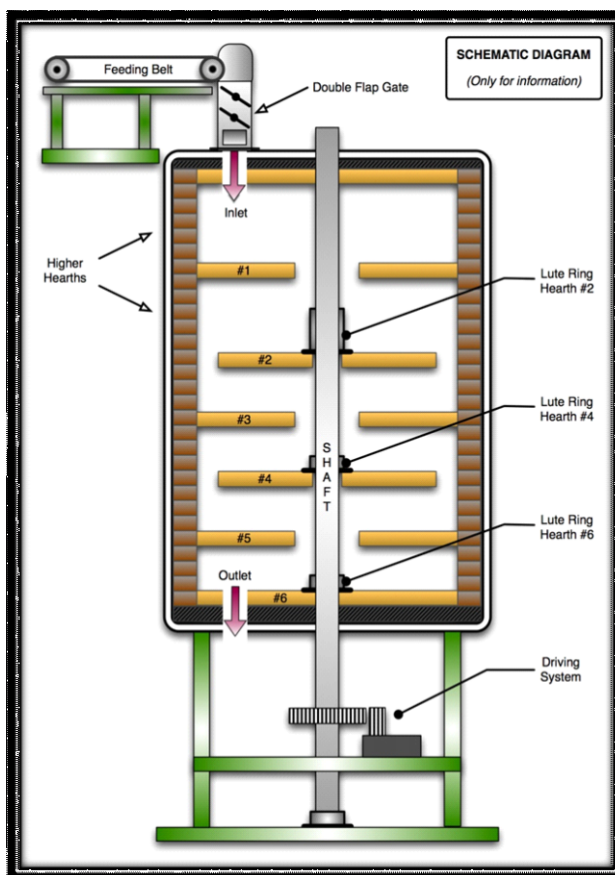

Figure 4.3 Multiple Hearth Furnace (MHF)

#### 4.4 Torbed reactor

The Torbed reactor technology can be considered as proven technology for various applications, including combustion. Batchwise and continuously operated Torbed installations with a diameter of 5 to 7 meters have already been built. Until recently however, torrefaction in a Torbed technology was only demonstrated batchwise on very small scale (2 kg/h). Recently a full scale demonstration plant was put into operation (see later in this report).

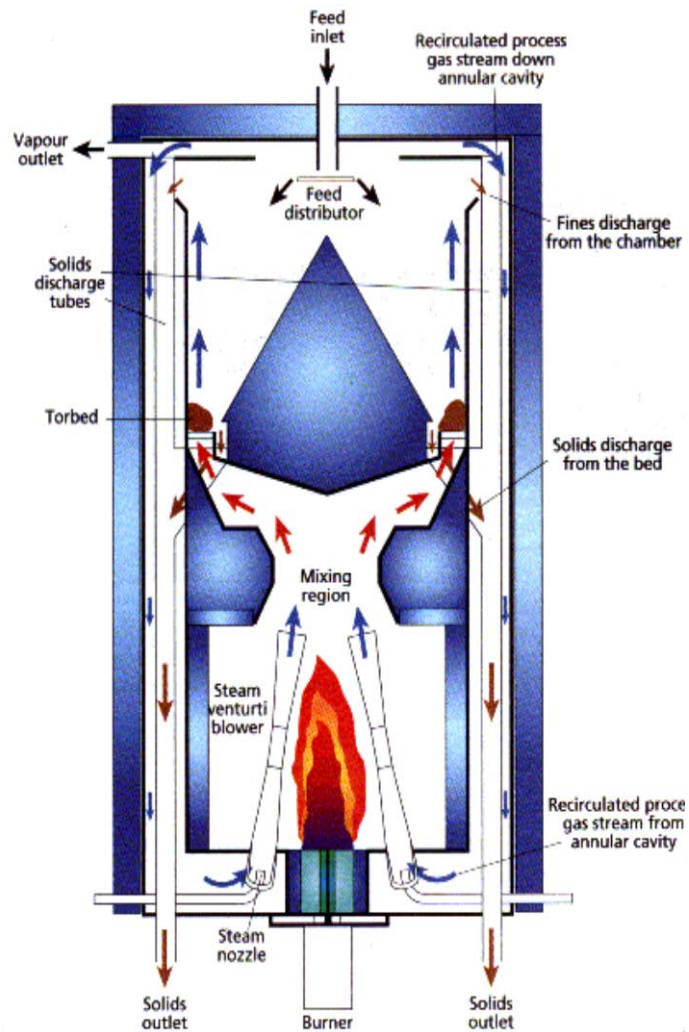

Figure 4.4 Torbed reactor

In a torbed reactor, a heat carrying medium is blown from the bottom of the bed with high velocity (50 - 80 m/s) past stationary, angled blades. This gives the biomass particles inside the reactor both a vertical and horizontal movement, resulting in toroidal swirls which very rapidly heat the biomass particles on the outer walls of the reactor. This relatively intense heat transfer enables torrefaction with short residence times (around 80 sec), which results in relatively small reactor sizes. The intense heat transfer could also be used to operate the reactor in a controlled way at elevated temperatures (up to 380 °C), resulting in higher loss of volatiles. This gives a technology a flexibility in preparing product for different end use markets. However, the process is sensitive to variation in particle size of the feedstock.

#### 4.5 Moving compact bed

This continuous reactor consists of an enclosed reactor vessel, where biomass enters from the top, and moves down gradually while the torrefaction process takes

place as a result of a heat carrying gaseous medium, which enters from bottom to top. The reactor does not entail any moving parts. At the reactor bottom, the torrefied product leaves the reactor and is cooled down. At the top of the reactor, gaseous reaction products (volatiles) are removed. The torrefaction process conditions are similar to the other technologies (residence time 30 - 40 minutes; process temperature approx 300 °C).

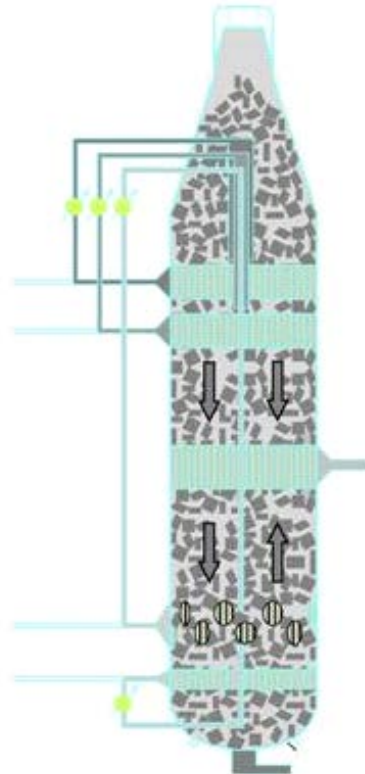

Figure 4.5 Moving compact bed

Due to the absence of proper mixing of biomass particles, there is a risk of channelling of the heat carrying medium through the bed, which leads to a non-uniform product at the reactor bottom. Though this effect has not yet been observed at a 100 kg/h test reactor, this risk increases for larger capacities.

The degree of filling of this reactor is relatively high if compared to e.g. the TORBED design, since the full reactor volume is used for the process. The pressure drop over the bed is relatively high, particularly when processing relatively small (<5 mm) biomass particles. This can partly be avoided by sieving the biomass input material, however, the formation of smaller particles inside the reactor cannot be avoided, particularly in the bottom of the reactor where the pressure is the highest. The limitation of the technology so far is the potential development of vertical “tunnels” causing un-even heat treatment across the diameter of the reactor as a result of variation of particle size of the feedstock.

## 4.6 Belt dryer

The belt dryer can be considered as proven technology for biomass drying applications. While biomass particles are transported using a moving, porous belt, they are directly heated using a hot gaseous medium. In a belt dryer reactor, usually multiple belts are placed on top of one another. While biomass particles fall from one belt on the other, mixing of the particles takes place, resulting in a more homogeneous product.

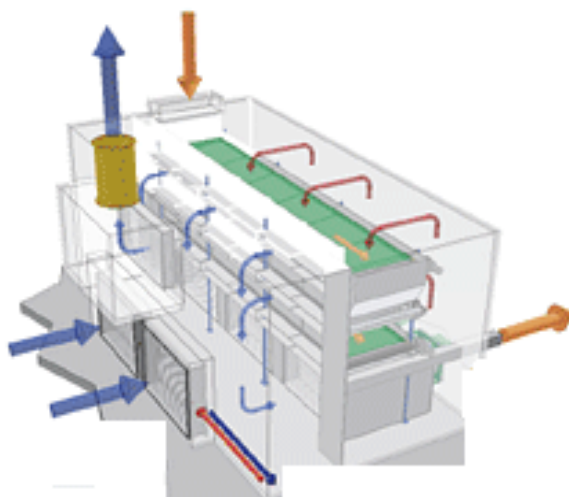

Figure 4.6 Belt dryer

By controlling the belt speed, the residence time for all particles inside the reactor can be accurately controlled. It can be considered a perfect plug flow reactor, in contrast to several other reactor concepts where there might be substantial spread in residence time, leading to either charred particles or not yet properly torrefied particles from the same reactor.

A disadvantage is potential clogging of the open structure of the belt from tars or small particles. Further, the volume limited throughput makes the reactor less suitable for biomass materials with low bulk densities. Also, the options for temperature control inside the reactor are limited since the process can only be controlled with the temperature of the gas entering the reactor and the velocity of the belt. Although specific investments for this reactor technology are relatively low, the relatively large space requirements limit the potential for upscaling.

## 4.7 Microwave reactor

An alternative option that has been tried to torrefy biomass is by using microwave energy. A key disadvantage, however, is that electricity is required for the microwave, which is difficult to produce with acceptable efficiencies from the torrefaction gas. This negatively influences the energy efficiency and the operational costs.



## 5 Applications of torrefied biomass

Torrefied biomass can be used for various applications; the most likely ones being co-firing with coal in pulverised coal fired power plants and in cement kilns, dedicated combustion in small scale pellet burners and gasification in entrained flow gasifiers that normally operate on pulverized coal. For all of these applications however, several issues remain to be verified.

Table 5.1 Potential applications for torrefied biomass [KEMA, 2010]

Market segment	Conversion process	Conversion technology	State-of-the-art biofuel	Pre-treatment requirements	Advantages of torrefaction	Market potential
Large-scale power production	Co-firing	Coal-fired boilers	Wood pellets	High	Process with the coal Higher co-firing rates	High
	(Co) gasification	Entrained flow gasifiers	Wood pellets	Very high due to particle size	Size reduction Fluidization C/H/O ratio very dry	Limited
	Stand-alone Combustion (>20 MWe)	CFB boilers	Wood chips	Moderate	Limited, relatively expensive	Small
Industrial heating	Combustion	Blast furnaces	none	Moderate	Handling, C/H/O ratio, Energy content	High
Residential/ District heating	Combustion	Stoves / boilers	Wood pellets	High, decentralized	Transport savings	High

### 5.1 Co-firing in pulverised coal fired power plants

The advantages of torrefaction are particularly recognized for use in (older) and existing pulverized coal (PC) fired power plants. Since these installations have not been designed for biomass co-firing originally, significant capital expenditures can be saved for modification of the plant when torrefied product is co-fired instead of regular wood pellets. This is particularly the case for torrefied clean biomass resources such as clean wood, which usually meets the constraints of existing environmental permits of the PC fired plant.

The combustion of torrefied biomass classified as waste (e.g. wastewood, roadside grass, and SRF (solid refused fuel)) typically needs to comply with stricter environmental requirements than the normal regime for clean biomass as a result of the European Waste Incineration Directive. Burning torrefied biomass produced from waste material results in a more stringent environmental operational regime and additional emission monitoring obligations. In addition, burning such fuels that are classified as waste may increase operational problems, related to additional



slagging, fouling or corrosion or negatively influence the quality of the ash resulting from the combustion. Energy companies are therefore somewhat hesitant to co-fire such fuels at present and generally prefer to use clean biomass feedstock for torrefaction. This might change in future in case torrefied wastes exhibit significant price benefits and have proven to result in acceptable operational plant performance.

New coal fired power plants that are currently in the planning or construction phase are designed for high co-firing ratios of lignocellulosic biomass, which makes the financial advantages of a torrefied biomass fuel with similar characteristics as the main fuel less obvious. Nonetheless, even in new PC boilers torrefaction might even lead to higher co-firing ratios than was originally envisaged for pure biomass co-firing, as it is a much better in replacement due to the similarity in terms of grindability and combustion. The financial drivers for co-firing torrefied biomass are therefore mainly determined by the replacement value of the coal and the market value of CO<sub>2</sub>.

## **5.2 Gasification**

The relatively low moisture content, good grindability and attractive C/H/O ratios make torrefaction an interesting pretreatment technology for gasification. For a gasifier using biomass, particle size and moisture contents are critical factors for good operation. This usually results in relatively expensive biomass feedstock. Torrefied and pelletised biomass is already uniform in particle size and has a very low moisture content, therefore the incremental fuel cost is less important for gasification as for an industrial combustor where cheaper biomass is normally used.

Gasification using torrefied biomass could potentially benefit from improved flow properties of the feedstock, increased levels of H<sub>2</sub> and CO in the resulting syngas, and improved overall process efficiencies. The grindability could be considered positive aspect in the case of entrained flow gasifier. As of yet, there is hardly any practical knowledge available on the options and limitations of torrefied biomass for gasification.

## **5.3 Blast furnaces**

There is a large potential for substituting coal in blast furnaces, given the lack of alternatives for CO<sub>2</sub> reduction. The main issues with torrefied material in a blast furnace are related to the alkali content and composition as well as the high volatile matter content. The steel industry is mainly interested in carbonised biomass, and the application of torrefied biomass seems limited.

## **5.4 Standalone combustion**

Standalone combustion installations are typically based on a grate furnace or fluidised bed furnace and lack the pulveriser which is present in PC plants. This makes them much more fuel flexible in terms of the fuel characteristics that are influenced through torrefaction (fuel particle size, physical appearance and



grindability). As the range of fuels that can be used in dedicated plants is mostly limited by the chemical composition (which is not influenced by torrefaction), there is hardly any reason for combining torrefaction with dedicated combustion.

An exception may be the application of relatively small scale pellet boilers that are used for space heating. In this case, fuel logistics may be significantly improved due to the increase in bulk energy density (see Table 3.1), which is particularly relevant in urban areas. One of the unknown issues here relates to public perception due to the change in colour and smell.



## 6 Economic value of torrefaction pellets

To assess the economical feasibility of the production and utilisation of torrefied biomass and consequently the market perspectives, it is important to consider the added value as compared to a reference case. This chapter gives an indication of the added value by comparing torrefied biomass pellets with wood pellets, both transported over longer distances.

For a proper analysis of the financial perspectives of torrefied wood in comparison to wood pellets, it is important to consider all process steps from the biomass resource to the pellet production (incl size reduction, drying, torrefaction and pelletisation) and end use of the product at the power plant.

### 6.1 Assumptions

Topell Energy recently developed a detailed economic assessment model with McKinsey and others in which the cost price of torrefaction pellets can be compared with that of wood pellets for a specific case (Topell, 2011). The assessment model includes an analysis of the costs for required handling and storage facilities at the PC power plant when co-firing wood pellets.

A case study was performed based on this model, in which a wood pellet production plant and a torrefied pellet plant of the same input capacity of 255 ktons per year of green wood (50% moisture content on wet basis) are located in South East coast, North America, 100 km from a deep sea port (suitable to handle bulk cargo), from where it is shipped to the Amsterdam – Rotterdam – Antwerpen (ARA) area.

The assumptions listed below were largely derived from detailed figures as delivered by Topell, based on a number of actual torrefaction projects that are currently being developed by Topell, but incorporated an independent assessment of these figures by some of the specialists in Task 32.

In the case study, a wood pellet plant is compared with a torrefied pellet plant. With the same input, the torrefaction plant produces 100 kton of torrefied pellets, the wood pellet plant 124 kton. It is here assumed that the same quality specifications are used for the biomass input material for the wood pellet plant and the torrefaction plant. There are however significant variations observed in input quality criteria for various torrefaction processes and pelletisation processes. For example, Topell claims that the option to remove ash in the dryer and torrefaction reactor enables the use of low grade wood residues materials such as (slash, treetops, etc) while wood pellet plant normally uses slightly more expensive whole logs. This potential price benefit in the input material claimed by Topell is not taken into account in this exercise, since this





in-situ ash removal aspect is not typical for all torrefaction processes currently under development.

Table 6.1 Assumptions for input and output in the case study by Topell

Feedstock	Wood Pellet	Torrefied Pellet
Feedstock intake (mt, 50% moisture)	255,000	255,000
Feedstock price (USD/mt)	35	35
Output capacity (mt)	123,800	100,000
Product LHV (GJ/mt)	17.5	21.7
Product bulk density (kg/m <sup>3</sup> )	620	800
Product energy density (GJ/m <sup>3</sup> )	10.7	17.4

The total investment of a wood pellet plant was estimated at 19.5 million USD, this includes the turn-key cost of the wood yard, pre-dryer, hammer mills, pellet mills, silos and civil works. The capital cost of a torrefied pellet is budgeted at 29 million USD and includes the turn-key cost of wood yard, pre-dryer, torrefaction reactors, pellet mills and civil works. It should be noted that these investment costs are significantly higher than those earlier published papers on the feasibility of torrefaction (e.g. by [Bergman, 2005] and [Uslu et.al., 2005]). The values in this case study are however based on experiences with actually built torrefaction plants and do also include turnkey costs, including outside battery limits while earlier published studies largely did not.

Table 6.2 Assumptions for the capital investment (million USD)

Cost components	Wood Pellets	Torrefied Pellets
Woodyard	5.0	5.0
Pre dryer (rotary drum)	4.5	3.6
Torrefaction		13.0
Hammermills	2.0	
Pelleting	4.0	3.1
Silo's	1.0	
Civil works & others	3.0	4.3
Total	19.5	29.0

In this case study, both plants were assumed to be financed the same way (15 y lifetime, 40% equity at 18% interest, 60 % debt at 7% interest, 2% inflation and 25% company tax). The capital costs for the torrefied pellet plant are therefore higher than that of the conventional wood pellet plant. Both plants are assumed to have the same labour, operating & maintenance and administrative costs. In the example, no technology licensing fees were taking into consideration.

There are significant differences in the electricity consumption of both processes. A smaller dryer is required as the moisture content before torrefaction is 10-20%



instead of 6-7% for a conventional wood pelletisation, the torrefied biomass hardly requires any grinding before pelletising whereas a hammermill is needed in case of wood pellet production. Not included is the grinding and screening the input biomass before dryer. With regard to the energy required for pelletisation, different figures are presented by industry. Topell has observed that with a right recipe for binders, energy consumption of 45 kWh/ton can be achieved, however other organisations list figures up to 150 kWh/ton. For this case study, we assume 150 kWh/ton. In total, the electricity consumption is about 54% higher at the production plant when compared to wood pellets. Electricity costs are valued at 60 USD/MWh<sub>e</sub>.

Table 6.3 Assumptions for electricity consumption (kWh per ton product)

Cost components	Wood Pellets	Torrefied Pellets
woodyard	20	20
predryer	45	33
hammermills	50	
torrefaction		60
pelleting	56	150
	171	263

Regarding transportation, it was assumed that the product fuel is first transported for 100 km by truck to the nearest port, from where it is shipped to Western Europe (ARA). From there, it is shipped by small barges to a power plant for a distance of 100 km. It is assumed that torrefied pellets are less costly per ton in handling and transportation due to their higher bulk density (in a ratio of 800 kg/m<sup>3</sup> vs 620 kg/m<sup>3</sup>, or 22% lower costs).



Table 6.4 Assumptions for logistics and infrastructure

Cost components	Wood Pellets	Torrefied Pellets
<i>Inland logistics from plant to port</i>		
Truck /Railway (\$/mt/100 km)	10	7.75
Distance (km)	100	100
Storage in port (\$/mt/day)	0.14	0.05
Number of storage days in port	45	45
Loading (\$/mt)	2.86	2.22
Demurrage (\$/mt)	0	0
<i>Deep sea shipment</i>		
<i>Deep sea shipment (\$/mt)</i>	35	27
<i>Inland logistics from port to utility</i>		
Loading (\$/mt)	2.86	2.22
Storage (\$/mt/day)	0.14	0.05
Number of storage days	14	14
Barge/Truck/Railway (\$/mt/100 km)	5.60	4.34
Distance (km)	100	100
Loading (\$/mt)	2.86	2.22

Once the pellets arrive at a pulverised coal fired power plant, additional investments will have to be made in case wood pellets are used, which can be largely or completely omitted in case of torrefied pellets. This concerns handling, storage, milling and feeding equipment at the power plant such as enclosed silos, separate pipework and hammermills or adapted coal mills. Total investment and O&M costs depend on the type and age of the power plant, typical additional investments are in the order of 100-400 Euro/kWe. [Schakel, 2011] suggests that the capital costs correspond to approx 47 Euro per kW per year, and O&M costs increase by 9.4 Euro/MWh due to changes in grindability, performance of the FGD and SCR/SNCR systems and ash content. The total costs estimated by Schakel (2011) are 1.93 USD/GJ of wood pellets, which are assumed to be avoidable if torrefied pellets are used. Of this amount, 1.4 USD/GJ are capital costs, the remaining 0.53 USD/GJ are operational costs.

## 6.2 Results

The product is transported by trucks to the port, where it is stored for 45 days waiting for a handy size vessel to ship it to the destination port of Amsterdam, Rotterdam and Antwerp (ARA). From ARA the product is shipped within 14 days to the end-users, either utilities, metallurgical companies, cement industry or others. The total transportation costs accrue to 4,11 USD/GJ for wood pellets and 2,40 USD/GJ for torrefied pellets.



Table 6.5 Cost structure for the case study in USD per GJ delivered fuel

Cost components	Wood Pellets	Torrefied Pellets	Savings
Cost of Biomass	4.28	4.28	0.00
Cost of Electricity	0.60	0.74	-0.14
Cost of Labour	0.47	0.47	0.01
Financial costs	1.01	1.49	-0.49
Other costs	0.40	0.43	-0.02
<b><i>COST PRICE AT PRODUCTION SITE</i></b>	<b><i>6.76</i></b>	<b><i>7.41</i></b>	<b><i>-0.65</i></b>
Inland logistics from the plant to port	1.12	0.57	0.55
Deep sea shipment	2.04	1.28	0.76
Inland logistics from the port to utility	0.94	0.55	0.39
<b><i>COST PRICE DELIVERED AT THE UTILITY</i></b>	<b><i>10.87</i></b>	<b><i>9.81</i></b>	<b><i>1.06</i></b>
Extra costs at the power plant	1.93	-	1.93
<b><i>Total costs of coal replacement</i></b>	<b><i>12.80</i></b>	<b><i>9.81</i></b>	<b><i>2.99</i></b>

The table shows that the production costs are slightly higher for torrefied fuels. The most important savings however can be achieved in transport and end use. It should be noted that the above cost price structure for both wood pellets and torrefied pellets already includes 18% RoE for the investor, however, a licensing fee for the torrefaction technology supplier is not included.

The cost structure for wood pellets in this case is more or less representative for current shipments CIF ARA (Amsterdam Rotterdam Antwerp). The mentioned cost price for wood pellets CIF ARA (10.87-0.94 =9.93 USD/GJ) complies approximately with the long term ENDEX pellet price index of approx 135 Euro per ton CIF ARA, or approx 10.5 USD/GJ<sup>1</sup>. After including inland shipping from port to power plant, the long term price delivered at the coal power plant amounts to approx 11 USD/GJ. In principle, power plants currently buying wood pellets at this price should be willing to pay the avoided cost of 1.93 USD/GJ at the power plant as well, which results in a total value of torrefied pellets of almost 13 USD/GJ at the current ENDEX pellet index, against a cost price of 9.81 USD/GJ as Table 6.5 illustrates.

The above cost prices can also be compared with the price of coal. For typical coal prices of approx 140 USD/ton (4.7 USD/GJ) delivered at the same coal fired plant, the difference is approx 5 USD/GJ for torrefied pellets. Evaluated against a specific CO<sub>2</sub> emission factor for hard coal of 98 kg/GJ, this makes torrefied pellets competitive at a CO<sub>2</sub> prices penalty of about 50 USD per ton of CO<sub>2</sub>. Although this is still significantly more expensive than the current market price for CO<sub>2</sub>, it is one of the cheapest options for CO<sub>2</sub> mitigation.

<sup>1</sup> at an exchange rate of 1.40 USD/EUR and LHV of 18 GJ/ton



## 7 Overview of project initiatives

This section provides international overview of some of the project initiatives. Table 7.1 shows an overview of about half of the torrefaction initiatives in Europe and North America. It is estimated that there are over 50 companies involved in developing torrefaction technologies. Most of these developers are relatively small (< 10 employees) and have a limited financial basis, resulting in the need to attract external investors. Due to confidentiality and the high commercial interest, it is not easy to obtain an up to date and reliable overview of the data. The below table should therefore not be read as complete and up to date, but is based on actual site visits, personal communication with key persons and questionnaires. The authors are aware of several other initiatives, however have not disclosed any information yet.

For more information on the status of initiatives listed, the reader is referred to individual websites of the companies mentioned.

In the sections below Table 7.1, some more detailed information is mentioned regarding a few of these initiatives.



Table 7.1 Overview of some torrefaction initiatives (KEMA, 2012b)

Developer	Technology	Supplier	Location(s)	Production capacity (t/a)	Status and scale Pilot scale: 50 kg/h – 500 kg/h Demo scale: > 500 kg/h – 2 t/h Commercial : > 2t/h)
Agri-Tech Producers LLC (US/SC)	Belt reactor	Kusters Zima Corporation (US/SC)	Unknown	Unknown	Pilot stage
Airex	Cyclonic Bed reactor	Airex	Laval, QC	Unknown	Pilot stage
Airless systems	Unknown	Atmosclear	Latvia	40,000	Out of business
Atmosclear SA (CH)	Rotary drum	CDS (UK)	Latvia, New Zealand, USA	50,000	Out of business
Bioenergy Development & Production	Fluidised Bed	Bioenergy Developmt & Production	Nova Scotia, CAN	?	Pilot
Bio Energy Development North AB (SWE)	Rotary drum	Unknown	Ö-vik (SWE)	25,000	
BioLake B.V. (NL)	Screw conveyor	Unknown	Eastern Europe	5,000 – 10,000	Pilot stage
Earth Care Products	Rotary drum	Earth Care Products	Kansas (USA)	20,000	Demonstration / commercial
EBES AG (AT)	Rotary drum	Andritz (AT)	Frohnleiten (AU)	10,000	1 mt/hr pilot plant in commissioning
ECN (NL)	Moving bed	Andritz (AT)	Stenderup (DK)	10,000	ECN combines technology with Andritz
FoxCoal B.V. (NL)	Screw conveyor	Unknown	Winschoten (NL)		Pilot, company now bankrupt
HM3 Energy	unknown	HM3	Oregan, US	?	Pilot building Demo plant
Integro Earth Fuels, LLC (US/NC)	TurboDryer	Stopped with Wyssmont (US/NC)	Roxboro, NC	80,000	Pilot stage
New Biomass Energy	Screw reactor	New Biomass Energy	Quitman, Mississippi, USA	40,000 160,000	Existing Commissioning
New Earth Renewable Energy Fuels, Inc (US/WA)	Fixed bed	Unknown	Unknown	Unknown	Out of business
Renergy/4Energy Invest (BE)	Rotary Drum	Stramproy Green Technology (NL)	Amel (BE) , Ham (Be)	38,000	Project terminated
Renergy/4Energy Invest (BE)	Rotary Drum	Stramproy Green Technology (NL)	Ham (Be)	38,000	Project terminated
River Basin Energy	Fluidised bed reactor	River Basin Energy	Laramie, Wyoming, USA	48,000	Pilot stage
Rotawave, Ltd. (UK)	Microwave reactor	Group's Vikoma	Terrace, British Columbia (CA)	110,000	Stopped in BC, announced partnership with Cate Street capital (Maine)
Horizon Bioenergy. (NL)	Oscillating belt conveyor	Stramproy Green Technology (NL)	Steenwijk (NL),	45,000	Operational again after plant fire in Feb 2012
Thermya (FR) / Grupo Lantec (SP)	Moving bed	Thermya (Fr)	Urnieta (SP)	20,000	Early stage commissioning
Thermya (FR) / LMK Energy (Fr)	Moving bed	Thermya (Fr)	Mazingarbe (Fr)	20,000	Early stage commissioning
Topell Energy B.V. (NL)	Torbed	Torftech Inc (UK)	Duiven (NL)	60,000	Final stage of commissioning
Torr-Coal B.V. (NL)	Rotary Drum	Unknown	Dilsen-Stokkem (BE)	35,000	
Torrefaction Systems Inc. (US)	Unknown	Bepex International (US/MN)	Unknown	Unknown	Pilot
WPAC (CA)	Unknown	Unknown	Unknown	35,000	
Wyssmont	turbodryer	wyssmont	US	Unknown	Unknown



## 7.1 Topell B.V. (Topell)

Topell B.V. currently has approx 45 employees and works closely together with Torftech Ltd., a British company which owns the patents for the Torbed reactor technology. Torftech has issued a global exclusive manufacturing license to Topell to apply the Torbed reactor technology for torrefaction globally. RWE owns almost 50% of the shares of Topell Energy. Another investor is Yellow & Blue (Vattenfall venture arm).

In Duiven, the Netherlands, the first full scale demonstration plant with 60 kton/year product capacity was built in 2010, and is currently (mid 2012) running at about 65-85% of design capacity. The biomass used mainly consists of forestry residues. The installation consists of multiple stacked Torbed reactors, which are placed in series for maximum flexibility in fuel characteristics and residence time.



Figure 7.1 The torrefaction demonstration plant of TOPELL in Duiven, the Netherlands (photo courtesy of TOPELL)

## 7.2 Green Investments (SGI)

SGI is a spin-off company of the Stramproy Group and consists of only 4 - 6 employees. The most important investor in SGI is the Belgian company 4Energy Invest, which also develops another torrefaction installation with SGI in Amel, Belgium.

The company has finalised the construction of a torrefaction demonstration installation in Steenwijk, the Netherlands with a production capacity of 45.000 tonnes per year. The torrefaction installation is based on a modified belt dryer. It is fed with wood and integrated with a biomass combustion based CHP unit (8 MW<sub>th</sub>). Low temperature heat from the CHP unit is used to dry the biomass to be torrefied.



Additional heat for the torrefaction process is delivered by a separate burner for the torrefaction gas.

Regretfully a plant fire in february 2012 significantly slowed down the commissioning process. Since summer 2012, the plant is again operational.

### 7.3 **Torr-Coal B.V.**

Torr-Coal is a relatively small company with 6 - 8 employees, who have developed their own torrefaction process based on a rotating drum.

Torr-Coal has built a torrefaction installation in Dilsen-Stokkem (Belgium) with a production capacity of 35 kton/year, with wood as feedstock. In addition, Torr-coal is planning two additional production lines based on Solid Recovered Fuels (SRF). For this purpose it has developed a washing process to reduce chlorine and sulphur contents.

### 7.4 **BioLake B.V.**

Biolake is a consortium of the Dutch research organisation ATO and 5 farmers, who have developed a torrefaction technology with Technical University of Eindhoven. A pilot plant has been built based on a rotating screw reactor of 1 ton per hour of straw as input material. The company claims to operate at a relatively short residence time (<10 min) at a torrefaction temperature of less than 270 °C. The reactor is indirectly heated by burning torrefaction gas. The aim is to realise mobile torrefaction units that can be placed near the biomass resource (particularly straw in Eastern Europe) with a capacity of 5 to 10 kton/year of torrefied pellets for the consumer market.

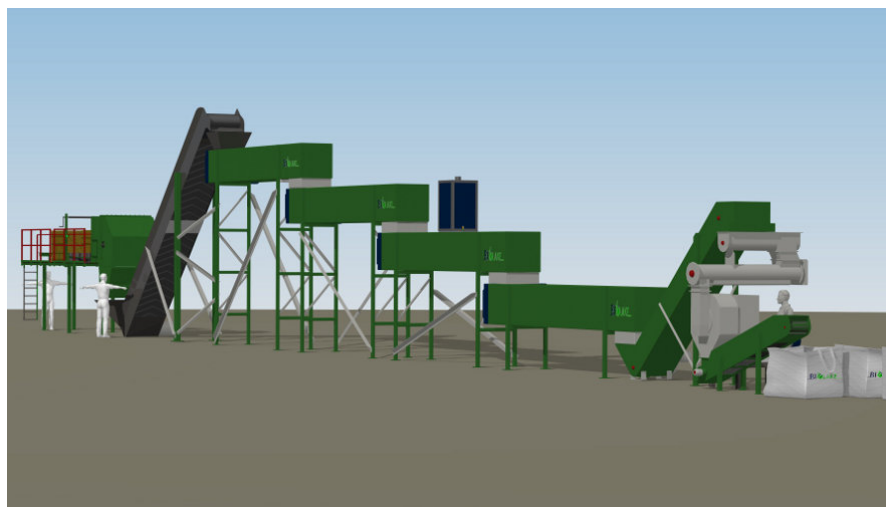

Figure 7.2 Schematic diagram of the BIOLAKE process, based on multiple torrefaction reactors in series (illustration courtesy of Biolake BV)





## 7.5 Airex Energy

Airex Industries was established in 1975 as a designer, manufacturer, and installer of specialised equipment in the industrial and commercial sectors, including dust collectors, industrial ovens, ventilators and other ventilation appliances. Airex Energy, division of Airex Industries, specializes in energy studies of industrial processes as well as in the design and manufacturing of torrefaction/carbonization equipment and combustion burners for torrefied biomass and biocoal.

Airex has started about 3 years ago with an internal research and development program on torrefaction. This resulted in development of CarbonFX technology. The current torrefaction facility with 250 kg/h input biomass capacity is located in Laval, Quebec, Canada. It has been in operation since March 2011 and has over 1,000 hours of operation. The process includes two-stage drying using hot flue gas. Torrefaction takes place in cyclonic reactor with torrefaction time of couple of seconds at temperature ranges between 290 – 365 deg C. The volatiles are converted to heat in the combustor and the resulting heat is used to dry the biomass. The torrefied material is being pelletised without the use of binder. The next developmental step is scaling up the process to 2 t/h by the end of 2013.



Figure 7.3 Predrying system and feeding bin of the Airex installation.



Figure 7.4 Cyclonic reactor and combustor of the Airex installation.

### 7.6 Andritz/ACB torrefaction technology

Andritz has developed and tested two processes to produce torrefied briquettes and pellets. The Andritz ACB technology platform is intended for production capacities from 50,000 to 250,000 tonne per year. The Andritz/ECN technology platform is intended for production capacities up to 700,000 tonne of torrefied pellets per year. These two technologies are reviewed briefly below.

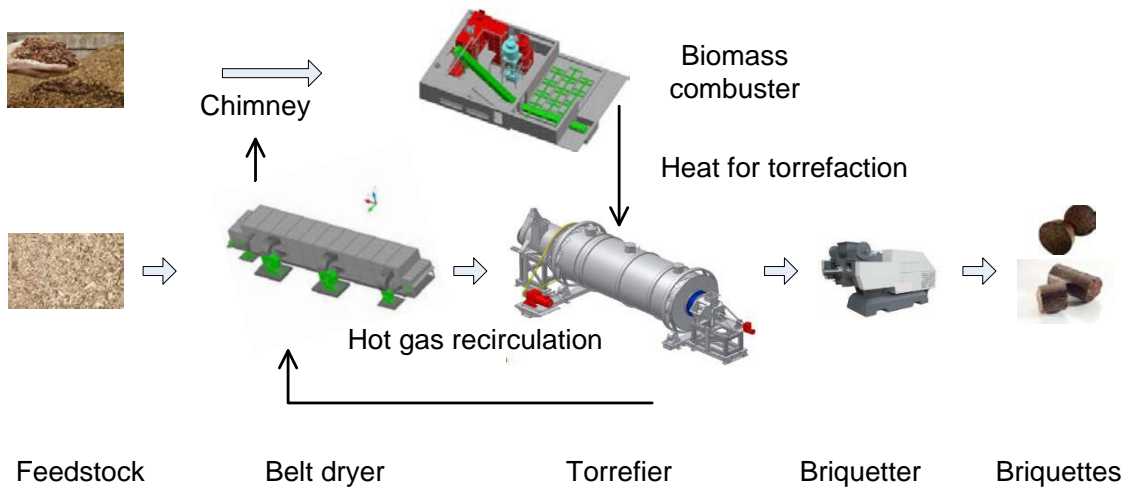

Figure 7.5 Andritz ACB process for small to medium capacity torrefied briquette production.



The Andritz ACB (Accelerated Carbonized Biomass) process shown in Figure 7.5 is intended for woody and herbaceous biomass. The biomass is initially dried on a continuous closed loop belt dryer. The dried biomass is torrefied in an air sealed rotary drum reactor. The heat transfer in this reactor is indirect, from heated surfaces to the biomass. Torrefaction takes place in the rotary drum at temperatures ranging from 250-300°C with a residence time of approx. 30 minutes. A biomass combustion plant provides heat to the torrefier and to the dryer. The heat for the dryer is also supplemented from the combusting gases from the torrefier. The torrefied biomass is cooled, ground, and briquetted or pelletized. The key feature of this system is simple process concept specially developed for decentralized plants, modular concept with flexibility in feed material. The Andritz ACB pilot plant was established between Andritz and Polytechnik in Austria and W&P consulting services as a consortium. The demonstration plant with a capacity of 1 tonne/h is operating in Frohnleiten, Austria since 2011 with an added briquetting capability in August 2012. The demo system can be scaled up in a modularized format.

### 7.7 Andritz/ECN torrefaction technology

The process shown in Figure 7.6 is intended for torrefying and pelletizing wood chips for large scale operations (~ 700,000 t/a). The process consists of a conventional rotary drum dryer followed by torrefaction and densification. The torrefaction reactor is a tall cylindrical structure in which the biomass enters from the top and exits from the bottom. Inside the pressurized chamber the biomass is further dried and torrefied in three or more stages. The biomass cascades downward spending time on a number of trays. Through the biomass bed on the trays, the flow of the hot gas with respect to biomass is a combined cross flow-concurrent flow. The partially torrefied biomass drops down to the lower packed bed section of the reactor where the biomass may undergo a final torrefaction period. Upon exit from the reactor, the hot torrefied biomass is cooled before being ground in a hammer mill and subsequently pelletized. Andritz and ECN have developed a 1 t/h demo plant in Stenderup, Denmark. The demo plant can be scaled up to large capacities possible in single line. The feed material is wood chips or forest residuals

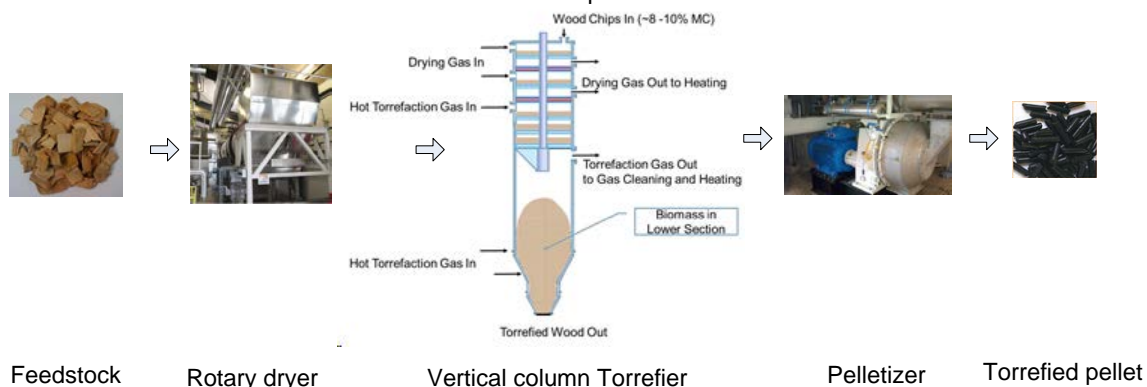

Figure 7.6 Andritz/ECN process for large scale capacity torrefied pellet production.



## 7.8 **New Biomass Energy**

New Biomass Energy, a company based in Quitman, Mississippi, USA has been producing torrefied material, including pellets and briquettes, from woody biomass since early 2011. This commercial plant is operated on a 24 hour, seven day a week basis with over 30 full time employees. Experimental runs have also been done with other materials such as miscanthus grass. Starting with a lab system for proof of concept and gradually upgrading to commercial production size the company is currently operating with 2 parallel reactors, each with a capacity of 2.5 to 3 tonnes/hour. Two larger reactors, each with a capacity of 6-8 tonnes/hour are currently in fabrication and will be operational in 2013 which will bring the total plant output up to about 18 to 22 tonnes/hour.

After a long evaluation period of available torrefaction technologies the company decided to develop their own system based on their intimate knowledge of how woody materials behave during thermal treatment. The reactor concept uses a unique screw mechanism and indirect heat transfer using oil as media. The torrefaction gas is combusted for heating in the torrefaction and drying process.

The company initially evaluated several pelletizers and decided to improve on existing commercial equipment starting at a small size and, after tedious experimentation, ending up with a design specifically tailored to compressing torrefied wood to durable pellets. The densification process has proven to be the most challenging part of the development cycle. The company found that a specific densification technology is not necessarily scalable from small test mills to full production scale. The research and development effort for pelleting extended over a year and utilized in excess of 25,000 tons of material. The pellet mills are now operating at a level that will handle the output from the reactors without interruption. The research and development included attention to the intricate design of dies (with testing of dozens of different die designs and specifications) and the experimentation with different binders for torrefied pellets reaching above 22 GJ/metric tonne.

The torrefied wood is hydrophobic. However, when the material is pelletized it is ground into small particles and then compressed, binding the smaller particles together. It has found that, depending on the binder used in the pelleting process, the bonds between the particles can breakdown when exposed to water. The company has found that small briquettes, 50 mm cubes, have a higher level of hydrophobicity compared to pellets and may have better compatibility with regular coal granules.



Figure 7.7 The NBE torrefaction Reactor



Figure 7.8 One of the hot oil systems at the NBE plant

The plant was designed to ensure that there is sufficient surge capacity between unit operations to minimize the effects of transients propagating through the production chain. The company does not consider itself a technology provider. It has partnered with several other firms to undertake research and development with the objective of creating an efficient production process for manufacturing torrefied solid biofuels.

A challenge that remains is the logistics of bringing the product to the clients in an economical and safe manner considering the demand imposed by economies of



scale and safety. Accumulation of sufficiently large volumes for shipment on barges and ocean vessels requires large storage facilities. Compressed torrefied wood, such as pellets, needs some weather protection to remain intact during large bulk handling. The dust generated has proven to be at least as explosive as dust from regular pellets and thus requires similar precautions of handling on land as well as on board vessels. The company has a special bulk shipping permit from the US Dept. of Homeland Security and the US Coast Guard and has successfully delivered thousands of tons in large transatlantic shipments of torrefied pellets for test burning in power plants and continues to produce product for future scheduled deliveries.

### **7.9 Earth Care Products Inc.**

Earth Care Products, Inc. (ECP) is located in Independence, Kansas, and has been in business of designing and supplying industrial processing, dehydration, and combustion equipment for biomass since 1992. Earth Care Products Inc. provides solutions for industrial dehydration and biomass densification systems with its patented Z8 Rotary Dryers, combustion systems, material handling and state-of-the-art control systems. It provides Engineered Biomass Solid Fuels through its proprietary torrefaction systems and ACTOF® (Ablazing Clean Torrefied Organic Fuel).

The ECP's mobile torrefaction system has production capacity of 60 t/day or 20,000 t/year and future plans for scaling up includes fixed plants up to 18 to 19 tph capacity. The ECP proprietary torrefaction process consists of three main stages: drying, torrefaction and cooling. During the drying, the biomass feedstocks less than 1/4" thick by 1.5" X 1.5" and around 40% moisture content are fed into the direct convection type Z8 Rotary Dryer. The heat for the dryer is supplied by the Biomass Burner which is a vertical dry cell biomass-fired burner. Turbulence created within the dryer leads to efficient and uniform drying of biomass chips at 3% to 4% moisture content and around 120°F to 130°F. The torrefaction process involves a rotary drum with a small angle of positive inclination. The drum rotates within an insulated shell through which the hot gases flow by means of an induced draft. Torrefaction temperature is maintained within the torrefaction reactor and no air flows inside the reactor which ensures an oxygen-starved environment. The biomass undergoes devolatilization and small amount of mass loss owing to the VOC's released. The VOC's given off are conveyed back to the Biomass Burner where they are incinerated. The hot gases providing heat to the reactor by conduction is conveyed to the dryer thus minimizing heat loss and improving the process efficiency. The torrefied biomass is then transferred airtight cooling stage. The cooler consists of a screw conveyor held inside a continuously-circulated water jacket. The water at ambient temperature is circulated through the jacket. Once, torrefied biomass cooled to controlled temperature, it goes into densification to increase its bulk density by 50% to 75% in pounds per cubic foot. Size and shape of densified product can be tailored to shipping and storage needs.



## 8 The Netherlands as case study

### 8.1 Demand for biomass for energy

The demand for biomass for energy generation in many countries is rapidly developing due to the increase in biomass co-firing and the erection of new dedicated bioenergy plants.

While somewhat over 1 Mtons of biomass per year is currently cofired with coal in Dutch power plants, the environmental permits already allow co-firing of about 2.8 million tons of biomass. This is predominantly imported biomass such as wood pellets. With the commissioning of approx. 3 GWe of new coal capacity able to cofire 30% on average, this will increase to about 5.5 million tons in 2020, assuming that the existing co-firing capacity is filled up to the level of the permits and that only the co-firing projects of RWE and E.ON are actually implemented. It is expected that also these new plants will predominantly use imported biomass.

Table 8.1 Overview of existing and planned co-firing plants (Sources: CE Delft, 2009 and KEMA)

	Capacity (MWe)	Biomass (kton/y)
<b>Existing coal capacity</b>		
Electrabel (Gelderland 13)	590	75
E.ON (maasvlakte 1+2)	1,040	207
Nuon (Hemweg 8)	630	40
Nuon (Buggenum)	250	20
Essent (Amer 8 en 9)	1,245	638
Essent (Amer 9 vergassen)	30	22
EPZ/DELTA (Borssele 12)	426	122
<i>Total existing coal co-firing</i>	<i>4,211</i>	<i>1,124</i>
<b>Planned coal capacity</b>		
E.ON (Maasvlakte 3)	1,070	1,108
RWE (Eemshaven)	1,600	1,657
Electrabel (Maasvlakte)	800	829
<i>Total planned coal co-firing</i>	<i>3,020</i>	<i>3,594</i>

### 8.2 Development of the Dutch market for torrefied biomass

There is significant interest in testing torrefied biomass for co-firing with coal. For a coal fired power plant to test torrefied biomass at substantial scale, a test implies several ten thousands of tons. In the Netherlands, purchase contracts have been signed with the power producers Essent en DELTA for a total volume of 170 kton/year of torrefied product. This volume was expected to be delivered fully in 2011

from the torrefaction installations of Stramproy Green Investment, Torr-Coal and Topell. However, all of these three installations have suffered delays in the startup due to debottlenecking and optimization of the process conditions, and as of late 2012 none of these installations are producing yet at expected capacity. These 3 installations will all using clean wood for the forementioned reasons.

KEMA has estimated how the supply capacity of torrefied product in the Netherlands will most likely develop in the medium term, given the likelihood that various initiatives mentioned in chapter 6 will develop (see Figure 2). The cumulative Dutch capacity of torrefied product in 2014 is estimated at 200 - 250 kton per year.

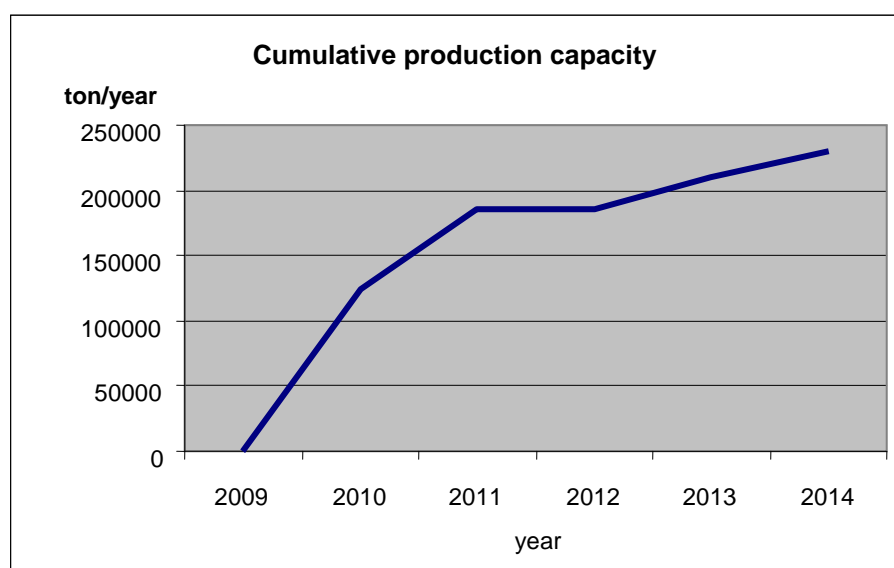

Figure 8.1 Estimated development of the cumulative Dutch torrefaction production capacity over time [KEMA, 2010]

### 8.3 Torrefaction of domestic biomass streams

It is interesting to explore the possible contribution of torrefaction technology in the utilisation of Dutch biomass resources. KEMA has analysed to what extend domestic biomass flows in the Netherlands could be used for co-firing after torrefaction. [Koppejan, 2009] estimates the domestic availability of biomass in the Netherlands at 47 Mton in 2020, of which around 10 Mton could be used for decentralize and centralized energy production.

In Table 8.2, an assessment is made of the suitability of the more substantial biomass streams (>200 kton/a in 2020) for torrefaction, based on the criteria listed in section 2.3.





Table 8.2 Suitability of torrefaction for available biomass types in the Netherlands. Expected availability figures in 2020 taken from [Koppejan, 2009]

	<b>Biomass</b>	<b>Available in 2020 (kt dm)</b>	<b>Quality improvement</b>	<b>Technical feasibility</b>	<b>Financial feasibility</b>	<b>Environmental aspects</b>
1	A-wood (clean wastewood)	420	++	++	+/-	++
2	B-wood (particle board, painted wood)	936	++	+	++	-
3	Clean virgin wood	383	++	++	+	++
4	Wood from harvested forest	498	++	++	+	++
5	Roadside grass	512	++	-	+	-
6	Nature grass	378	++	-	+/-	++
7	Solid Recovered Fuels	800	+	+/-	++	-
8	Paper residues	239	++	+/-	-	-
9	Sewage sludge	349	-	-	-	-
10	MBM	85	-	-	-	-
11	Animal fats	788	-	-	-	-
12	Animal dung	1.933	-	-	-	-
13	Poultry litter	2.030	-	-	-	-

The biomass categories 1 - 8 contain a significant lignocellulosic fraction that justify a torrefaction process. In general, clean wood resources (type 1, 3 and 4) can be torrefied against acceptable techno-economical and environmental performance. Types 3 and 4 are relatively cheap as well. This makes clean virgin wood and freshly harvested wood currently most popular as biomass resources for torrefaction.

The environmental consequences of using waste materials (e.g. B-wood, paper sludges or solid recovered fuels) are more complex. In the Netherlands, this will already require a detailed (and therefore time consuming and expensive) environmental impact assessment study if more than 100 ton/day is processed (31.250 t/j). The first torrefaction installations that are currently starting up in the Netherlands, are all larger than this threshold. Further, it is expensive that these types of biomass will face significant competition from new dedicated biomass power plants, even in the industry sector where they originate from. Finally, when using such input materials, additional flue gas cleaning equipment needs to be installed at the torrefaction plant. Relatively high concentrations of alkali metals, chloride,



sulphur, nitrogen, heavy metals and ash might impose the need for additional flue gas cleaning based on baghouse filters with active carbon injection, or wet scrubbers. This negatively affects the financial feasibility of the torrefaction installation.

SRF (solid recovered fuel) is an interesting biomass containing waste stream due to the relatively low market price and high heating value. Recently, the international trade in SRF in Europe has been made easier due to new European legislation. Paper sludge is a relatively small stream in the Netherlands, but can be interesting in other countries.

## 9 Challenges for market implementation

This chapter summarises some of the most important techno- economical and legislative challenges for market implementation of torrefaction technologies.

### 9.1 Technical challenges

#### Feedstock flexibility

The currently developed torrefaction technologies have relatively limited feedstock flexibility in terms of particle size and moisture content; substantial pretreatment is therefore required. Typical input particle size is 5 to 20 mm, moisture content of input material for the reactor not exceeding 15% on wet basis to avoid incomplete combustion of wet torrefaction gases and minimise the process residence time.

The use of agri-residues with low bulk density such as hay or straw needs larger reactors compared to woody biomass; which leads to increases in capital cost and more difficult to operate. This is one of the reasons why most projects currently process wood.

#### Treatment of torrefaction gases

The torrefaction gas released during the process consists of CO<sub>2</sub>, CO and various organic compounds such as acetic acid, formic acid, methanol, phenols, furfural, fluor compounds and other light organics, see Figure 9.1.

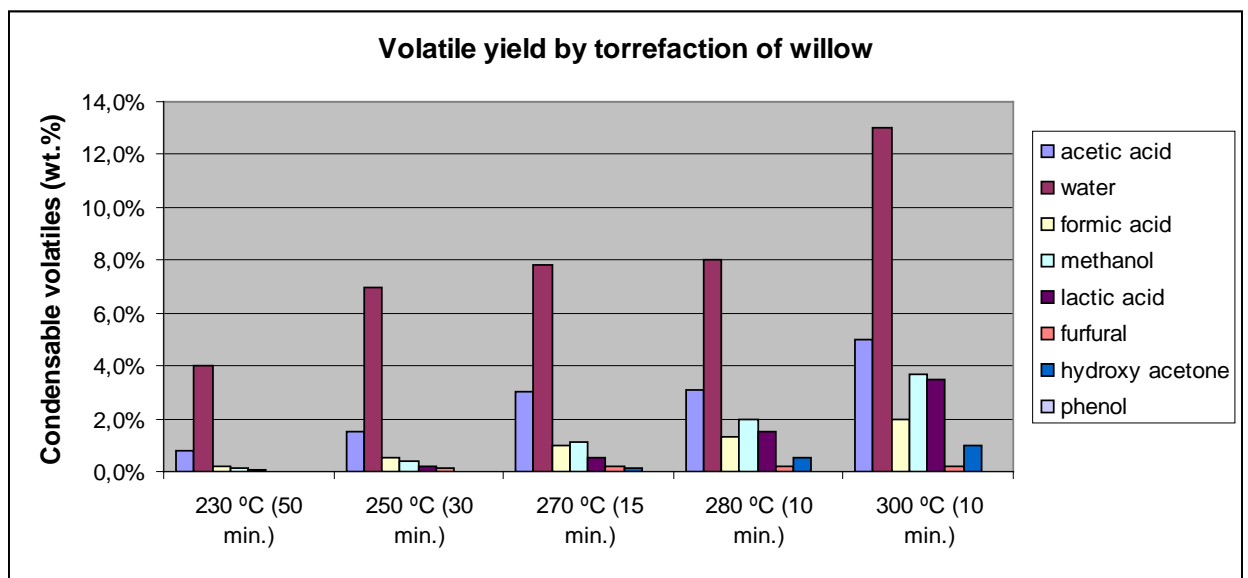

Figure 9.1 Composition of volatiles released during torrefaction of willow at different temperatures (Prince, 2005)



The torrefaction gas is normally de-dusted using a cyclone, before being used as a fuel to dry incoming biomass. More heavy tars present in the torrefaction gas may condense in the pipework before the burner, resulting in operational problems. For this reason, the torrefaction gas pipework needs to be insulated. For proper operation of the torrefaction gas burner, sufficient residence time, mixing with combustion air and flame temperature (>900 °C) are required.

In case substantial amounts of F, S or Cl are present in the feedstock, treatment of the burner flue gases using an active coal filter or wet precipitator may be required. For clean biomass fuels however, a dust filter may be sufficient. NO<sub>x</sub> emissions are low due to the low combustion temperature of the gas.

**Scaling up the process**

Depending on the reactor type, it can be a serious challenge to scale up torrefaction processes from pilot (typically 20-600 kg/h) to commercial scale (5-10 ton/h or larger). In case of screw reactors, drum reactors or belt conveyors, the limited scaleability will often make it necessary to establish multiple production lines in parallel. For example, a scaled up moving bed might lead to the unwanted “tunnel” effect, resulting in an uneven heat distribution over the reactor. When scaling up a screw reactor, the ratio between screw surface area and reactor volume decreases resulting in lower efficiency.

Table 9.1 Overview of major reactor types by technology developer [KEMA, 2011, UBC, 2012]

Reactor	Technology developer
Rotary drum reactor	CDS (UK), Torr-Coal (NL), BIO3D (FR), EBES AG (AT), 4Energy Invest (BE), BioEndev/ ETPC (SWE), Atmosclear S.A. (CH) , Earth Care Products Inc. (US), Andritz/ACB (AU)
Screw conveyor reactor	BTG (NL), Biolake (NL), FoxCoal (NL), Agri-tech Producers (US), New Biomass Energy (US)
Herreshoff oven/ Multiple Hearth Furnace (MHF)/ TurboDryer®	CMI-NESA (BE), Wyssmont (US),
Cyclonic torrefaction reactor	Airex (CND)
Torbed reactor	Topell (NL)
Microwave reactor	Rotawave (UK)
Compact moving bed	ANdritz/ECN (NL), Thermya (FR), Buhler (US)
(Oscillating) Belt conveyor	Stramproy Green Investment (NL)

**Process control and Product Quality/Consistency ?**

The control of the temperature profile and residence time of the solid biomass in the torrefaction reactor is crucial for an efficient process and optimal product quality. The ability to control these parameters varies between the different torrefaction concepts.



In general, torrefaction processes based on indirect heating are more difficult to control, resulting in an increased risk on carbonisation and consequently a lower conversion efficiency and lesser product homogeneity. In all cases, a well controlled biomass particle size and composition (usually clean wood) leads to better process controllability and product quality. When deviating to other feedstock, obtaining adequate process controllability becomes more difficult.

## **9.2 Macroeconomic challenges**

The market value of the product is the most important driver for development of torrefaction processes. Though power producers are often interested in the product, they do not always wish to take all promoted quality aspects into consideration when negotiating prices, e.g. avoided costs at the power plant for handling and storage, as well as cost related to ash processing, and avoidance of NO<sub>x</sub> and SO<sub>2</sub> emissions. This is largely related to the perceived risks in the behaviour of the torrefied product. As long as torrefied products are not yet properly standardised in terms of their health and safety requirements, milling behaviour, and combustion behaviour, large amounts of torrefied product will not be co-fired and only small scale co-firing trials are done. Recently a large EU-FP7 funded research project 'SECTOR' was initiated to address several existing issues that hamper large scale use of torrefied materials.

Another barrier for rapid market introduction of torrefaction technologies is the commercial basis for development of a torrefaction production plant. This is particularly true in areas where there are industries/sectors competing for the same feedstock, and prices cannot be secured for larger quantities over time as this leads to higher biomass prices and lower margins. Increased torrefaction process flexibility (as e.g. claimed by Topell) would reduce this dependency, but this requires further R&D from the current technology status where mainly high quality wood chips are used. It is therefore essential that the first generation of torrefaction technologies yields enough expertise and profit to invest in the development of more flexible technologies.

From an energetic and environmental aspect, it is important to maximise the energy efficiency. From a commercial aspect however, it can be tempting to increase throughput by increasing process temperatures at shorter residence times, however this leads to reduced process efficiency since more volatiles are released. For example, an additional 10% product loss might be commercially acceptable if a double throughput can be achieved.

With a history in biomass co-firing, the Netherlands has been one of the leading countries in the development of torrefaction technologies. However as time progresses other countries are rapidly catching up (see section 7). With regard to the location of commercial torrefaction projects, it can be observed that the first demonstration plants are currently built in the Netherlands, France, Spain and North



America. As the technology matures, however, is likely that the more large scale, fully commercial torrefaction installations will be built in North America, Africa and South America, where large biomass resources are available. From there, the product is shipped to areas where the largest interest in co-firing is (today this is western Europe). As the market for torrefied fuels matures, other end user markets will also develop interest in using torrefied fuels.

The demand for regular wood pellets is also increasing rapidly, as the interest in co-firing is increasing in North America due to co-firing obligations and incentives. Also in Germany and UK, significant dedicated combustion projects are currently under development for regular wood pellets. Torrefaction projects may make it possible to transport torrefied fuels over longer distances, thereby unlocking remote resources of biomass and transporting them globally (similar to coal).

### **9.3 Regulatory issues**

For the development of a market for torrefaction products it is important that regulatory issues are properly and timely addressed. This concerns both national and international legislation on waste treatment, end-of waste criteria, standardisation and classification of fuels, development of sustainability criteria, and serious consideration of health and safety issues related to production, transportation, handling and storage as well as energy conversion

For example, REACH registration will require companies involved in torrefaction to carefully administer resources, intermediate products and final products, with relatively high associated costs for the relatively small companies currently involved in demonstrating torrefaction technologies.

There is only limited experience yet in issuing environmental permits for torrefaction installations. Of the three licences issued in the Netherlands, two were issued by provincial authorities, and one by a municipality. In these permit procedures, an extensive environmental impact assessment study was not regarded necessary since the biomass concerned was not regarded as waste. If it would have been waste however, an expensive and time consuming environmental impact assessment study would have been required if the installations would have a processing capacity exceeding 100 tons per day of input material. This is a significant barrier for implementing waste based torrefaction installations and can only be justified if the financial performance is sufficiently attractive. A good example of a torrefaction company involved in torrefying waste is Torr-Coal. This company plans to develop two SRF torrefaction lines of 35 kton/year each at its location in Dilsen-Stokkem (Belgium). The local provincial authority currently evaluates the need for performing an EIA.



Regular wood pellets are currently transported in large bulk in large ocean vessels regulated by the International Maritime Organization (IMO). Charcoal is also regulated by IMO but is not allowed to be transported in bulk due to the reactive nature of the product. Torrefied material such as torrefied pellets and briquettes are currently not registered as a commodity and can therefore not be shipped in ocean vessels without special permission. To become an approved commodity under IMO torrefied pellets must be classified under an acceptable standard and fulfil certain criteria in terms of predictable quality and have definable safety attributes. In other words, torrefied pellets must become a standardized product for example under the new ISO standards under development. The incorporation of the torrefied pellets as a tradable commodity a formal application must be done and the application process usually takes 2-3 years or longer and has to be preceded by extensive testing. Typically, a product standard and international safety code issued by IMO is a prerequisite for obtaining liability insurance for large fuel supply contracts.



## 10 Recommendations

The above mentioned challenges for accelerated market implementation can be addressed in several ways by either market or government organisations. This section provides some recommendations.

### **Scaling up using clean biomass**

The optimal degree of torrefaction depends on several technical and economical factors, such as the type of feedstock, requested product specifications, technical design of the reactor, the achievable degree of process control, options for heat integration and emissions. Economical factors are cost of biomass, cost of pre-treatment, mass loss of product during torrefaction, achievable process throughput and product sales price. Understanding and developing the optimal combination of these factors requires time and money. At the same time, the first commercial clients usually request product in quantities which require upscaling of pilot plants by typically a factor of 100. In order to limit the risks and development effort in debottlenecking while scaling up, the first commercial installations are currently designed for using clean biomass. It still needs to be proven if the first full scale installations will meet their design conditions and throughput.

### **Gaining commercial experiences**

The main driver for development of torrefaction technologies is the anticipated commercial returns. In the negotiations of prices between the most important offtakers (energy companies) and the torrefaction companies, uncertainties about milling behaviour, combustion behaviour, storage aspects, self heating and safety aspects play an important role. As a result, there is also uncertainty about potential cost savings at the power plant, which lowers the price benefit for the fuel. While R&D work is ongoing for smaller scale experimental work (e.g. in the areas of milling and combustion characteristics), full scale co-firing trial of a few days should also be performed to test the handling and storage behavior, for this purpose at least 5000 tons will be needed.

The Dutch companies involved in developing torrefaction have joined forces in the Dutch Torrefaction Association to standardize the product. Torr-Coal claims to have developed an adapted Hard Grove Index (HGI) which could be suitable for torrefied material. In 2012-2014, the EU funded project SECTOR will also address several of these key issues that hamper rapid commercialisation.

### **Product standards**

In order to accelerate the market for torrefied products end users should obtain sufficient confidence in the quality of the products procured. Product standards become mandatory for increasing transparency between producers and end users





and for the use of product to gain acceptance in the market. Current standards for biomass often do not include the option of torrefied products. It is known that in this situation, end users set unreasonable product standards which can hardly be met by the producers. It is therefore important that torrefied products are properly included in existing harmonisation efforts for new CEN, ISO and national standards, where the various product quality specifications are defined through constructive interaction between producers and end users of the material.

### **Sustainability standards**

In order to benefit from the reduced logistical costs of torrefied material, it is likely that torrefaction installations will be built in areas with large biomass quantities. The upcoming ISO 248 sustainability standards for bioenergy which covers the entire supply chain therefore need to include torrefied materials.

With regard to various sustainability standards, the ISO 248 Quality Control and Quality Assurance standards under development will form the basis for traceability. After torrefaction, the origin of the biomass used is difficult to identify, particularly when biomass from multiple sources is torrefied in the same process. This would imply that administration of resources and products need to be accurately performed and this is where international product certification standards will play a role.

### **Torrefying wastes**

The attractiveness of co-firing torrefied wastes still needs to be explored further. At this stage, energy companies are hesitant in co-firing torrefied wastes, due to the associated emission legislation (in Europe the Waste Incineration Directive), as well as possible negative influences on ash quality, emissions and boiler performance. It is yet uncertain if the additional operational cost associated with these factors is compensated by a lower price per GJ.

Torrefied waste can be gasified or directly burned, however there are also technologies available that process the waste directly. Again, it is yet unknown if the torrefaction step yields sufficient technical or economical advantages in the next process.

Governments could assist in increasing transparency in this situation by supporting research that addresses the suitability of torrefied wastes for these processes, so that end users make more rational judgments when considering co-firing or gasifying the material.



## 11 Conclusions

Torrefaction significantly improves the suitability of biomass for co-firing in coal fired power plants, and has the potential to enable higher co-firing percentages at reduced cost. The torrefaction technology is now proven in pilot scale, and the first initiatives are underway to demonstrate the technology at commercial scale (50,000 to 70,000 tons/year and above). Although some of the energy content contained in the dry biomass is lost during the torrefaction process as volatiles, acceptable overall efficiencies of approximately 90% can still be obtained since this energy is used to dry the moisture out of the biomass. As both of these sub-processes result in a substantial loss of mass, a significant increase in energy density is obtained.

### **Technical challenges: from demonstration to commercial operation**

The most important technical challenges in the development of torrefaction processes relate to achieving constant and well controlled product quality, scaling up the process, obtaining high system efficiency through proper heat integration, flexibility in terms of input materials and be able to densify the material to a durable pellet or briquette which can be handled without generation of large amounts of highly explosive dust. The optimal process conditions still need to be determined for the various concepts. Most of the R&D up-to-date is done with clean wood, and it is likely that the first commercial installations will also operate on high quality biomass. Torrefaction of agro-residues will be more complicated due to the challenging physical and chemical characteristics. This would only make it feasible to develop suitable torrefaction processes in case significantly lower prices for the input material can be secured.

The technical and economical advantages of torrefied pellets are recognised by most of the larger power producers. In the Netherlands this has led to off-take contracts for the product, and consequently bank financing for two torrefaction installations with a total projected capacity of 80 kton/year. KEMA estimates that this will increase to 200 - 250 kton/year in 2014.

### **The business case**

The economic analysis in this report illustrates that there could be a business case for torrefaction. Under the given conditions, torrefied pellets could be delivered to the power plant for lower prices than wood pellets, mainly due to savings in shipping cost. In addition, it is likely that the similarity to coal will enable higher co-firing percentages for torrefied pellets as compared to regular wood pellets (or even complete fuel switching), without significant modifications to a power plant..

The actual market price of torrefied pellets however is not only determined by the cost price, but also is the result of negotiation between supply and demand. In this



process, perceived risks are taken into account when setting the actual price. Only when significant commercial production starts up and trade volumes increase will the true market value of torrefied pellets or briquettes be established.

**More transparency in legislation required**

A number of issues related to regulation and legislation need to be addressed. Most important seems the need for product standardisation to provide confidence with both producers and end users of the material. It is important that the CEN, ISO and national product standards include torrefied biomass.

It is also important that sustainability criteria are defined in such a way that the use of torrefied material is included, since this is often a prerequisite for obtaining necessary subsidies for renewable energy. Quality control and quality assurance standards will have to be introduced to the industry for proper tracing of materials and products. Product quality certification will follow as the market demand is established and torrefied fuel products become tradable commodity on the international market.



## 12 References

- Bergman, P.C.A., 2005, Combined torrefaction and pelletisation - The TOP process, ECN report ECN-C--05-073, 2005
- CE Delft. 2009. Duurzame elektriciteitsmarkt? Delft.
- Ciolkosz, D., Wallace, R., A review of torrefaction for bioenergy feedstock production, *Biofuels*, *Bioprod. Bioref.* 5:317–329 (2011)
- ISO 17225-1 Solid Biofuels – Fuel Specifications and Classes – Part 1: General Requirements.
- KEMA, 2008. Statusdocument Bio-energie 2008. In opdracht van SenterNovem.
- KEMA, 2010, Statusoverzicht en impactanalyse van torrefaction in Nederland, in opdracht van AgentschapNL, rapportnummer 30920555-Consulting 10-0508
- KEMA, 2011: Overview of the European torrefaction landscape, Ronald Meijer, EPRI Biomass Torrefaction Workshop, April 13-14, 2011, Pensacola, FL, US
- KEMA, 2012a, Status of North American and European torrefaction initiatives, Presentation at the World Sustainable Energy Days 2012, Wels, Austria.
- KEMA, 2012b, Cracked biomass, Article submitted to *Renewable Energy World* magazine, April 2012
- KEMA, 2012c, Private Communications, April 2012
- Koppejan, J. 2009. Beschikbaarheid van Nederlandse biomassa voor elektriciteit en warmte in 2020. Eindversie. November 2009. SenterNovem.
- LAP2 (2009 -2021) (Dutch waste management plan), [www.infomil.nl](http://www.infomil.nl) .
- NTA 8003. Classificatie van biomassa voor nuttige toepassing. Nederlandse Normalisatie Instituut.
- Prince, M.J. 2005. Thermodynamic analysis of biomass gasification and torrefaction. PhD Thesis. Technische Universiteit Eindhoven.
- Repellin, 2010, Energy requirement for fine grinding of torrefied wood, *Biomass and Bioenergy* 34 (2010) 923 – 930



Schakel W., 2011, Economical analysis co-firing torrefied pellets in coal plants, University of Utrecht

Stelte W., Dahl J., Nielsen N.P.K., Hansen H.O., 2012, Densification concepts for torrefied biomass, IEA Bioenergy Task 32 / Sector workshop, Milan, 2012

Uslu A., Faaij A. P.C., Bergman P.C.A. , Pre-treatment technologies, and their effect on international bioenergy supply chain logistics. Techno-economic evaluation of torrefaction, fast pyrolysis and pelletisation, Energy 33 (2008) 1206– 1223

Vergunningsaanvraag Topell B.V. Locatie Duiven. Provincie Gelderland.

Vergunningsaanvraag Stramproy Green Investment B.V. Locatie Steenwijk. Gemeente Steenwijkerland.

Vergunningsaanvraag Torr-Coal. Locatie Dilsen-Stokkem. Provincie Limburg, België.

Vahrenholt, F. Gassner, H. 2010. The Growth Strategy of RWE Innology –Role of RES in RWE's strategy. VGB PowerTech 2010.

Yan, W., et al., "Mass and energy balances of wet torrefaction of lignocellulosic biomass," Energy and Fuels, 2010.

Yan, W., et al., "Thermal pretreatment of lignocellulosic biomass," Environ. Progress and Sustainable Energy 28 (3) 435-440 (2009).